



Pamasol Willi Mäder AG

Driesbühlstrasse 2
8808 Pfäffikon SZ
Switzerland

Tel. +41 55 417 40 40
Fax +41 55 417 40 44

electrics@pamasol.com
www.pamasol.com

ELEKTROSCHEMA

Projektnummer	Pick_and_Placer	
Projektbeschreibung	Pick and Placer	
Kunde	Pamasol Willi Mäder AG Driesbühlstrasse 2 8808 Pfäffikon Schweiz	
Kommission	Schulung	
Vertretung	-	
Installationsort	Pfäffikon SZ	
Projektverantwortlicher	philippb	
Projektanfang	10.08.2021	
Letzte Änderung	11.08.2022	von FABIANS
Datum	11.08.2022	

Strukturkennzeichenübersicht

Vollständige Bezeichnung	Strukturbeschreibung
Funktionskennzeichen	
=A1	Pick and Placer-Modul
Ortskennzeichen	
+CC	Steuerschrank
+CONV	Transportband
+PIPL	Pick&Placer
+PIPL.HMI	Pick&Placer Bedienstelle
+Reports	
Dokumentenart	
&AAA	Titel- / Deckblatt
&ADB	Strukturbeschreibung
&MTL	Schaltschrankdisposition
&EFA1	Übersicht Externe Geräte
&EFA2	Übersicht Topologie
&EFS	Schaltplan Elektrotechnik
&MFS11	Schaltplan Pneumatik
&EPC	Stückliste Elektronik
&MPC	Stückliste Mechanik
&EPA	Artikelsummenstückliste
&EMB	Kabelübersicht

		Revision		Pamasol Willi Mäder AG				Strukturkennzeichenübersicht		Pick_and_Placer		=		&ADB	
		Bearb. FABIANS		Driesbüelstrasse 2				Schweiz							
		Gepr		8808 Pfäffikon		Schweiz		www.pamasol.com		Schulung		+		Seite 2	
Änderung	Datum	Name	Datum	11.08.2022	Druckdatum	11.08.2022	Letzte Änderung	11.08.2022	FABIANS	Pick and Placer			Blatt		2 von 37

Verdrahtung

Hauptstrom: schwarz
 Nullleiter: hellblau
 Steuerung 230V: PH. schwarz / N. hellblau
 Steuerung 230V ab Trafo: PH. rot / N. rot-weiss
 Steuerung 24V AC: PH. grün / N. grün-weiss
 Steuerung 24V DC: + dunkelblau / - blau-weiss
 Messspannung: weiss
 Fremdspannung: orange
 Stromwandler: braun

Strombelastbarkeit

EN 60204-1:2018 B2

Leistungsteil minimal :1.5mm²
 Steuerungsteil :1.0mm²
 SPS Eingänge - Ausgänge :0.5mm²
 Exi / Eigensicher :0.5mm²

Querschnitt [mm ²]	Strombelastbarkeit [A]
0.75	8.5
1.0	10.1
1.5	13.1
2.5	17.4
4	23
6	30
10	40
16	54
25	70
35	86
50	103
70	130
95	156
120	179

NEC Tabelle 310-16

Leistungsteil minimal :AWG 16
 Steuerungsteil :AWG 18
 SPS Eingänge - Ausgänge :AWG 20
 Exi / Eigensicher :AWG20

Querschnitt [AWG]	Strombelastbarkeit [A]
20	5
18	7
16	10
14	15
12	20
10	30
8	40
6	55
4	70
3	80
2	95
1	110
1/0	125
2/0	150
3/0	175

Kabelfarben

WH: weiss
 BN: braun
 GN: grün
 YE: gelb
 GY: grau
 PK: rosa
 BU: blau
 RD: rot
 BK: schwarz
 VT: violett

Verdrahtung

- UL-Verdrahtung
- Halogenfrei
- Litzenbeschriftung

Klemmen

Weidmüller

Graviersprache

Deutsch

			Revision		Pamasol Willi Mäder AG				 Spezifikation	Pick_and_Placer	=A1	&AAA	
			Bearb.	mathiass	Driesbühlstrasse 2					Pick and Placer-Modul	Titel- / Deckblatt		
			Gepr		8808	Pfäffikon	Schweiz	www.pamasol.com		Schulung	+CC	Seite	2
Änderung	Datum	Name	Datum	11.08.2022	Druckdatum	11.08.2022	Letzte Änderung	23.07.2020	mathiass	Pick and Placer	Steuerschrank	Blatt	3 von 37

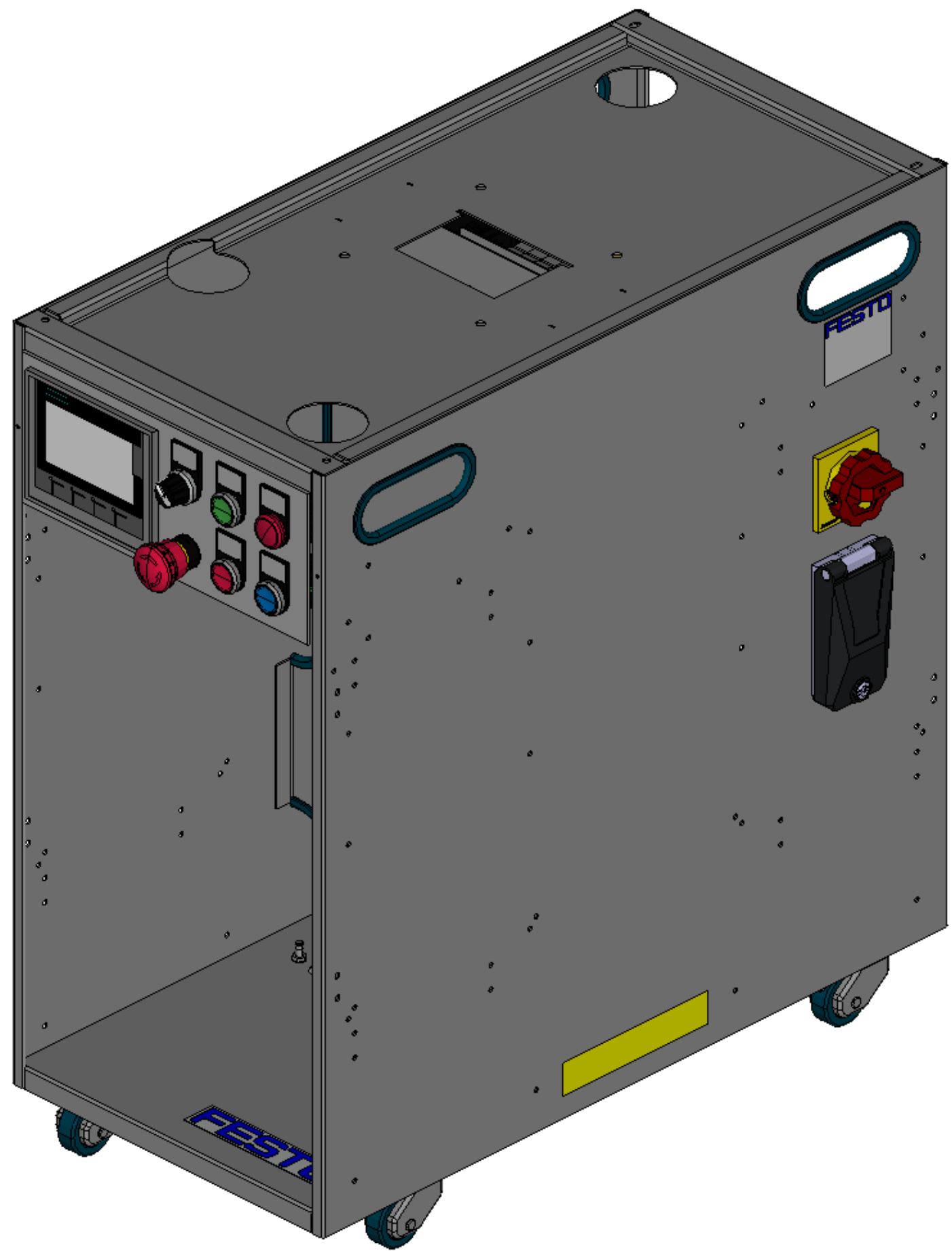

			Revision		Pamasol Willi Mäder AG					Schaltschrankdisposition - 3D Ansicht	Pick_and_Placer	=A1	&MTL
			Bearb.	FABIANS	Driesbühlstrasse 2							Pick and Placer-Modul	Schaltschrankdisposition
			Gepr		8808	Pfäffikon	Schweiz	www.pamasol.com				+CC	Seite 1
Änderung	Datum	Name	Datum	11.08.2022	Druckdatum	11.08.2022	Letzte Änderung	11.08.2022	FABIANS	Pick and Placer	Schulung	Steuerschrank	Blatt 4 von 37

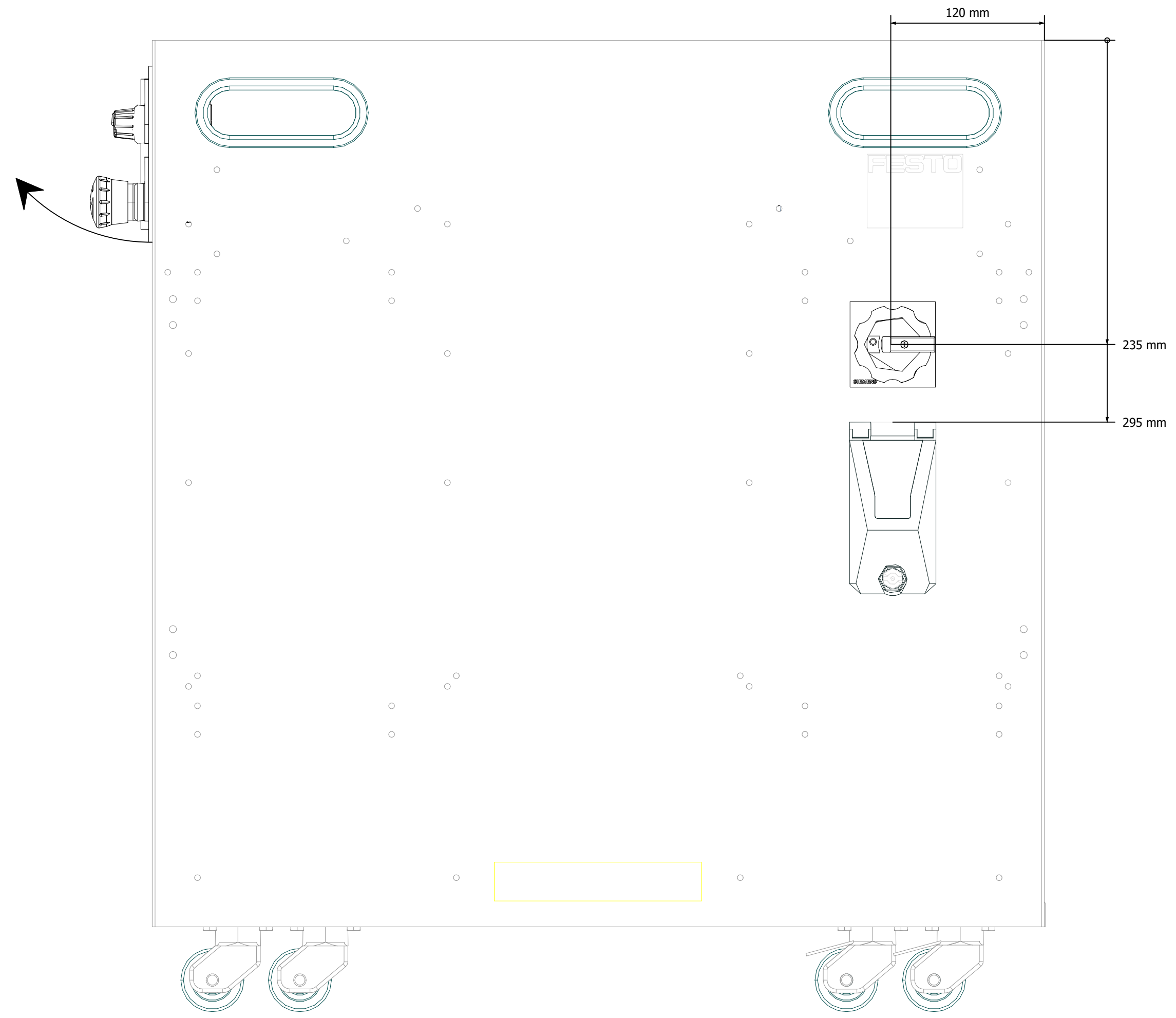

			Revision		Pamasol Willi Mäder AG					Schaltschrankdisposition - 3D Ansicht	Pick_and_Placer	=A1	&MTL
			Bearb.	FABIANS	Driesbühlstrasse 2							Pick and Placer-Modul	Schaltschrankdisposition
			Gepr		8808	Pfäffikon	Schweiz	www.pamasol.com				+CC	Seite 2
Änderung	Datum	Name	Datum	11.08.2022	Druckdatum	11.08.2022	Letzte Änderung	11.08.2022	FABIANS	Pick and Placer	Schulung	Steuerschrank	Blatt 5 von 37

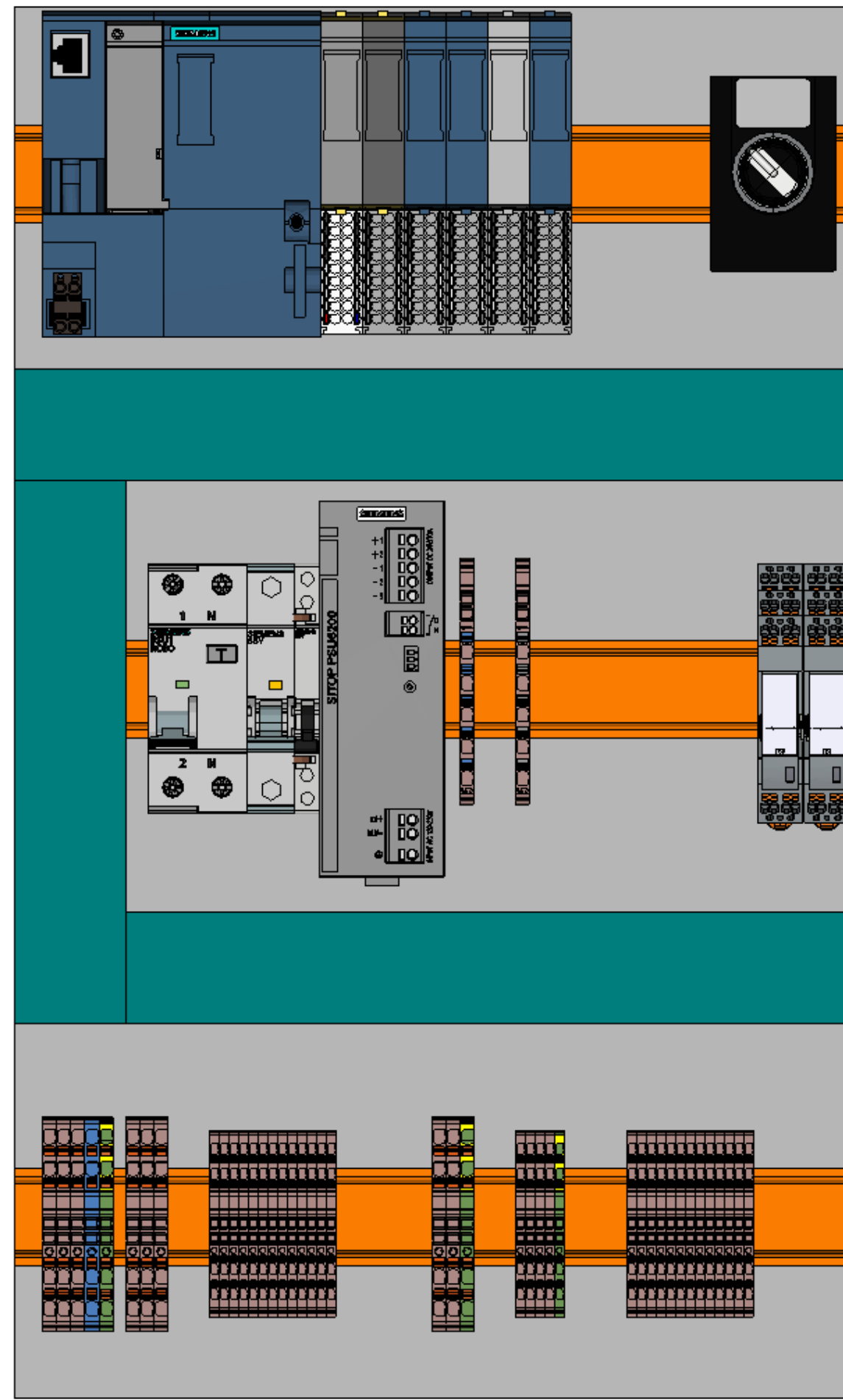

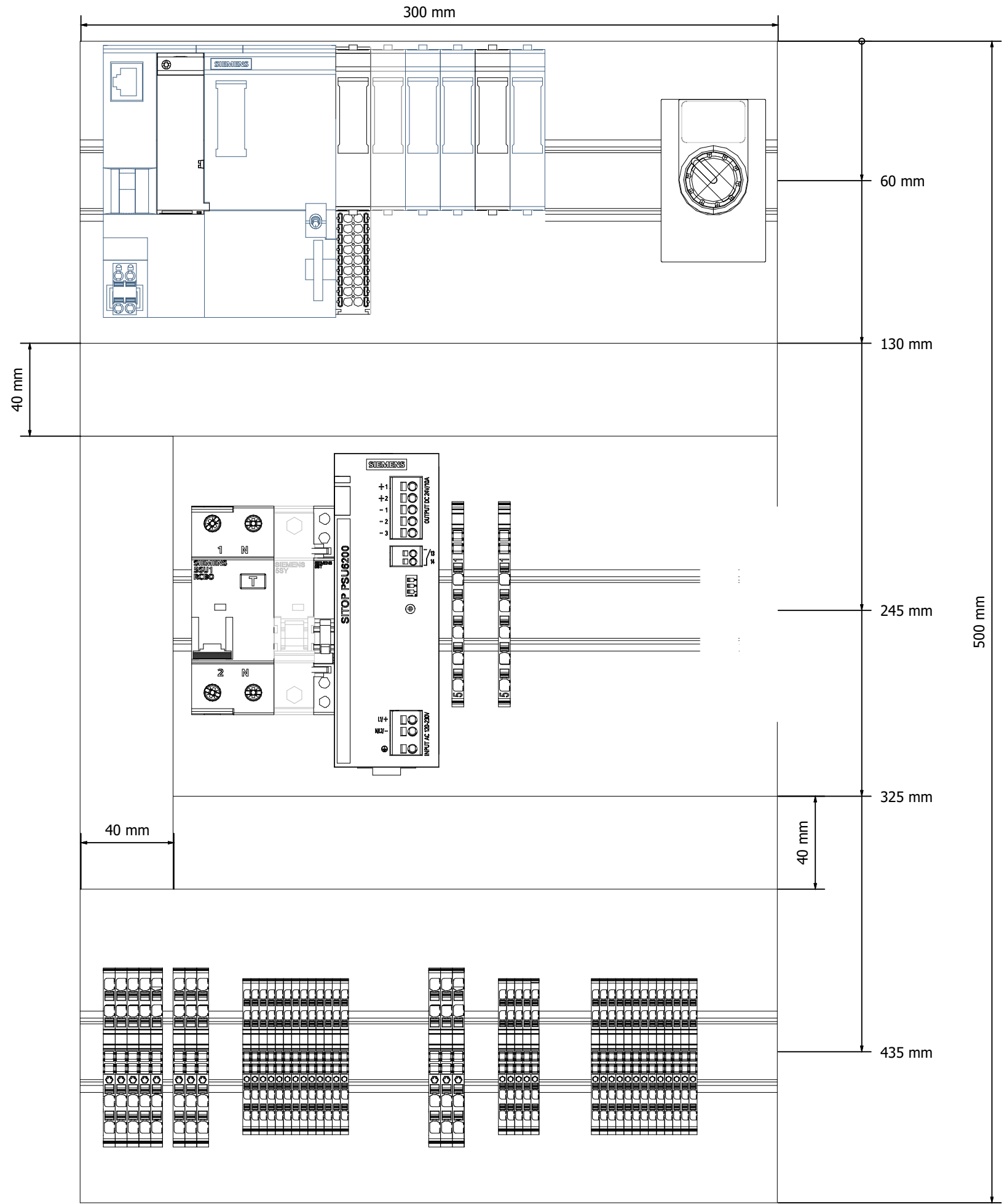

			Revision		Pamasol Willi Mäder AG					Schaltschrankdisposition - 3D Ansicht	Pick_and_Placer	=A1	&MTL	
			Bearb.	FABIANS	Driesbühlstrasse 2							Pick and Placer-Modul	Schaltschrankdisposition	
			Gepr		8808	Pfäffikon	Schweiz					+CC	Seite	5
Änderung	Datum	Name	Datum	11.08.2022	Druckdatum	11.08.2022	Letzte Änderung	11.08.2022	FABIANS	www.pamasol.com	Pick and Placer	Steuerschrank	Blatt	6 von 37

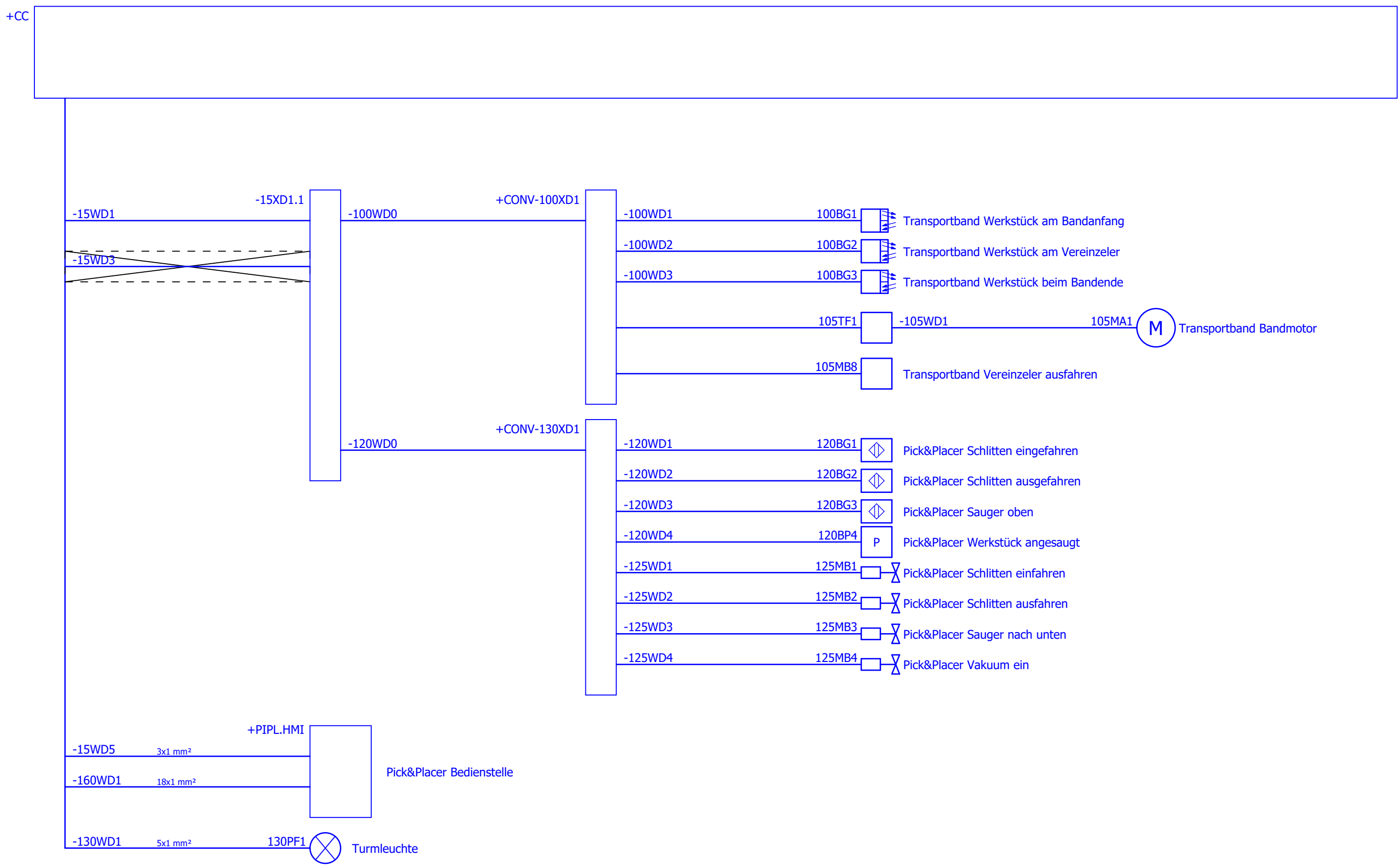

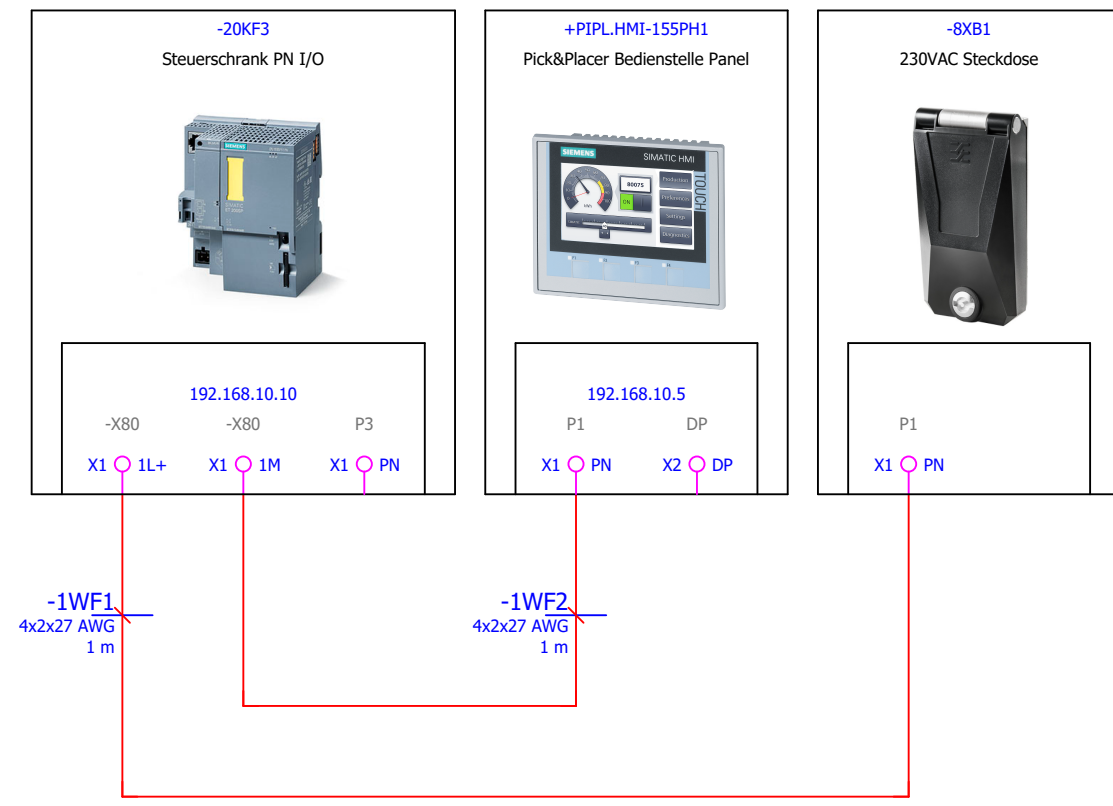

Pamasol Willi Mäder AG													Übersicht Externe Geräte		Pick_and_Placer		=A1		&EFA1	
Driesbüelstrasse 2													pamasol		Pick and Placer-Modul		Übersicht Externe Geräte			
8808 Pfäffikon Schweiz													Swiss Aerosol Solutions							
Schweiz													www.pamasol.com		Schulung		+CC		Seite 1	
Druckdatum 11.08.2022 Letzte Änderung 11.08.2022 FABIANS													Pick and Placer		Steuerschrank		Blatt 8 von 37			



		Revision	Pamasol Willi Mäder AG		 Übersicht Topologie	Pick_and_Placer	=A1	&EFA2				
		Bearb.	Driesbühlstrasse 2				+CC	Übersicht Topologie				
		Gepr	8808 Pfäffikon Schweiz				+CC	Seite 1				
Änderung	Datum	Name	Datum	11.08.2022	Druckdatum 11.08.2022	Letzte Änderung 17.05.2022	fabians	www.pamasol.com	Pick and Placer	Schulung	Steuerschrank	Blatt 9 von 37



VORSICHT!

Steht auch bei ausgeschaltetem
Hauptschalter unter Spannung

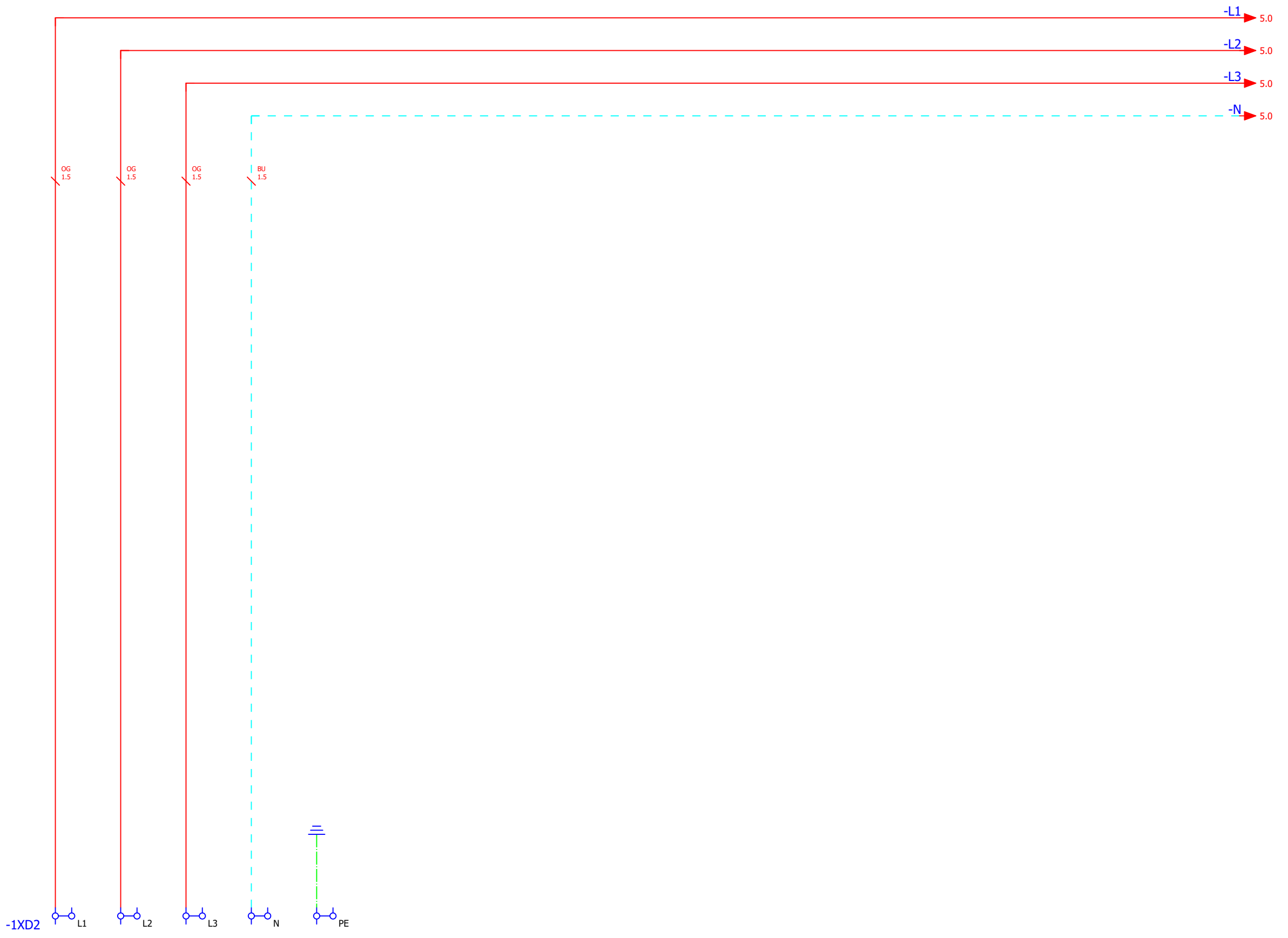

Einspeisung 400VAC 50Hz

			Revision		Pamasol Willi Mäder AG				 Swiss Aerosol Solutions	Einspeisung	Pick_and_Placer	=A1	&EFS			
			Bearb.	joelg	Driesbühlstrasse 2						Pick and Placer-Modul	Schaltplan Elektrotechnik				
			Gepr		8808	Pfäffikon	Schweiz				+CC	Seite	1			
Änderung	Datum	Name	Datum	11.08.2022	Druckdatum	11.08.2022	Letzte Änderung	12.01.2022	joelg	www.pamasol.com	Pick and Placer	Schulung	Steuerschrank	Blatt	10 von	37

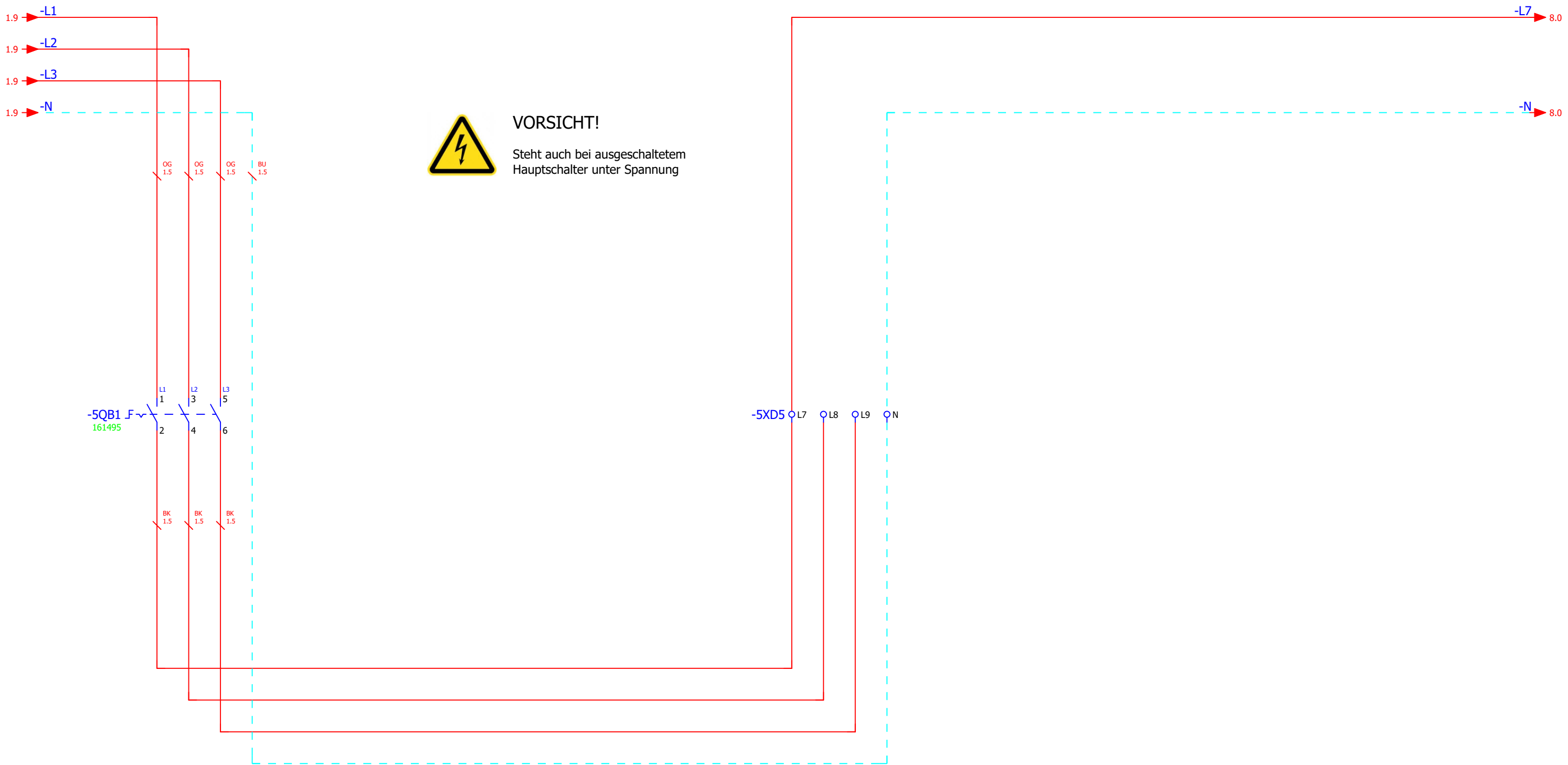

Hauptschalter

Stützpunktklemmen nach Hauptschalter

1													8												
Pamasol Willi Mäder AG													Hauptschalter												
Driesbühlstrasse 2													Pick_and_Placer												
8808 Pfäffikon Schweiz													=A1												
www.pamasol.com													Pick and Placer-Modul												
Schweiz													+CC												
www.pamasol.com													Steuerschrank												
Schweiz													Seite 5												
www.pamasol.com													Blatt 11 von 37												
www.pamasol.com													Seite 5												
www.pamasol.com													Blatt 11 von 37												

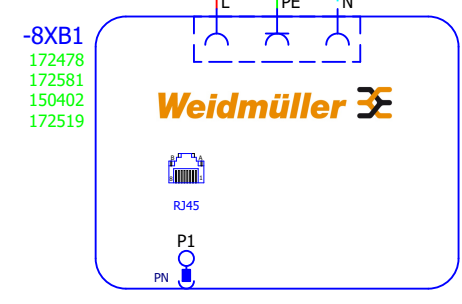
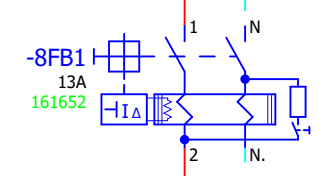

230VAC Steckdose

5													10												
Revision													Pamasol Willi Mäder AG												
Bearb. FABIANS													Driesbühlstrasse 2												
Gepr													8808 Pfäffikon Schweiz												
Datum 11.08.2022													Druckdatum 11.08.2022 Letzte Änderung 11.08.2022 FABIANS												
Name													www.pamasol.com												
Änderung													Steckdose												
Datum													Pick_and_Placer =A1												
Name													Pick and Placer-Modul &EFS												
Datum													Schulung +CC Seite 8												
Name													Steuerschrank Blatt 12 von 37												

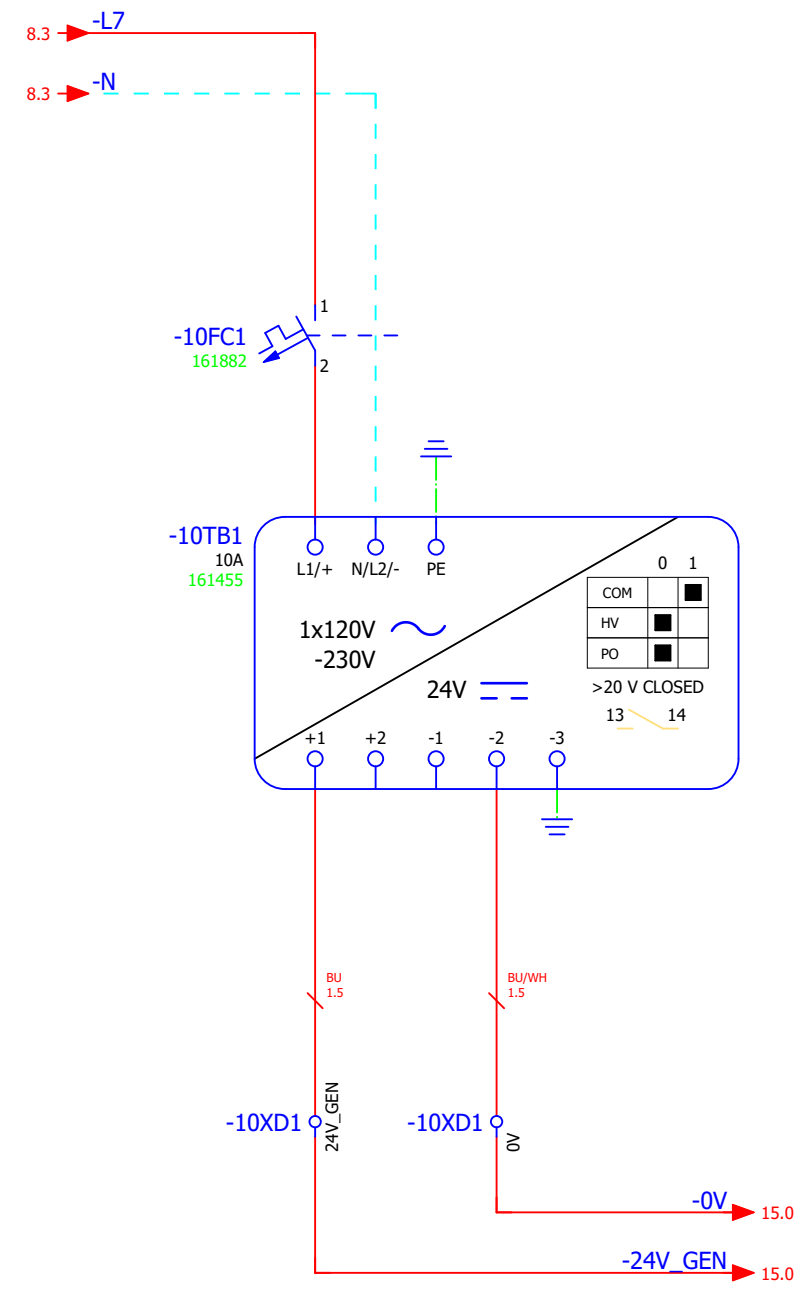

24VDC Versorgung

			Revision		Pamasol Willi Mäder AG				 24VDC Versorgung	Pick_and_Placer	=A1	&EFS		
			Bearb.	FABIANS	Driesbühlstrasse 2						Pick and Placer-Modul	Schaltplan Elektrotechnik		
			Gepr		8808	Pfäffikon	Schweiz				+CC	Seite 10		
Änderung	Datum	Name	Datum	11.08.2022	Druckdatum	11.08.2022	Letzte Änderung	11.08.2022	FABIANS	www.pamasol.com	Pick and Placer	Schulung	Steuerschrank	Blatt 13 von 37

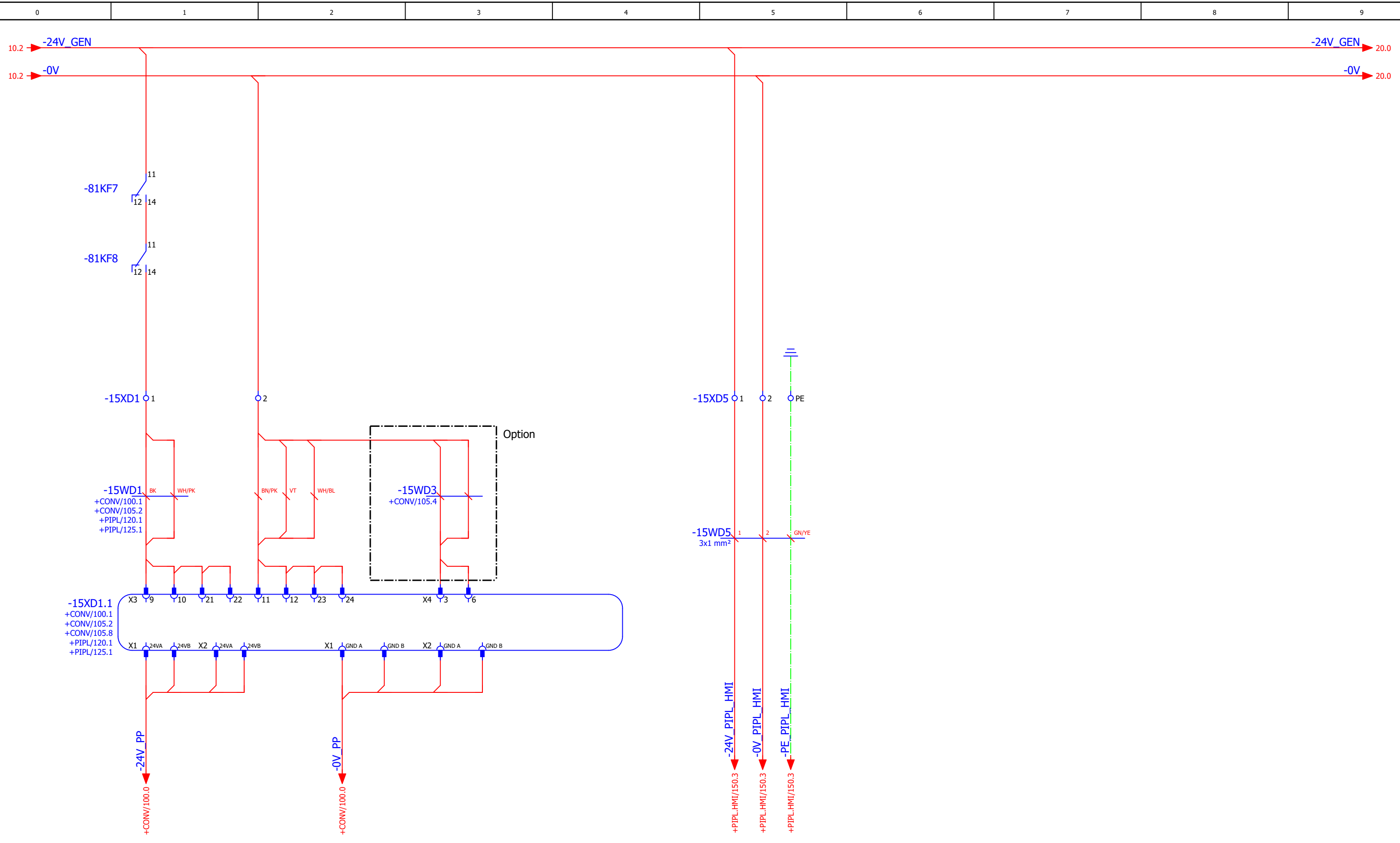

Einspeisung Pick&Placer

Einspeisung Bedienstelle

10										20									
										Revision									
										Bearb. fabians									
										Pamasol Willi Mäder AG									
										Driesbüelstrasse 2									
										8808 Pfäffikon Schweiz									
										pamasol Swiss Aerosol Solutions									
										24VDC Versorgung									
										Pick_and_Placer									
										=A1									
										Pick and Placer-Modul									
										Schaltplan Elektrotechnik									
										+CC									
										Seite 15									
Änderung										Datum									
Name										Datum									
11.08.2022										11.08.2022									
Druckdatum										Letzte Änderung									
25.04.2022										fabians									
www.pamasol.com										Pick and Placer									
										Schulung									
										Steuerschrank									
										Blatt 14 von 37									

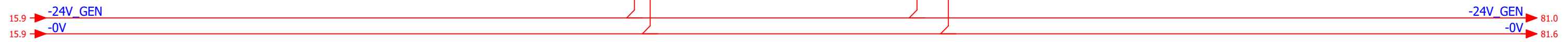
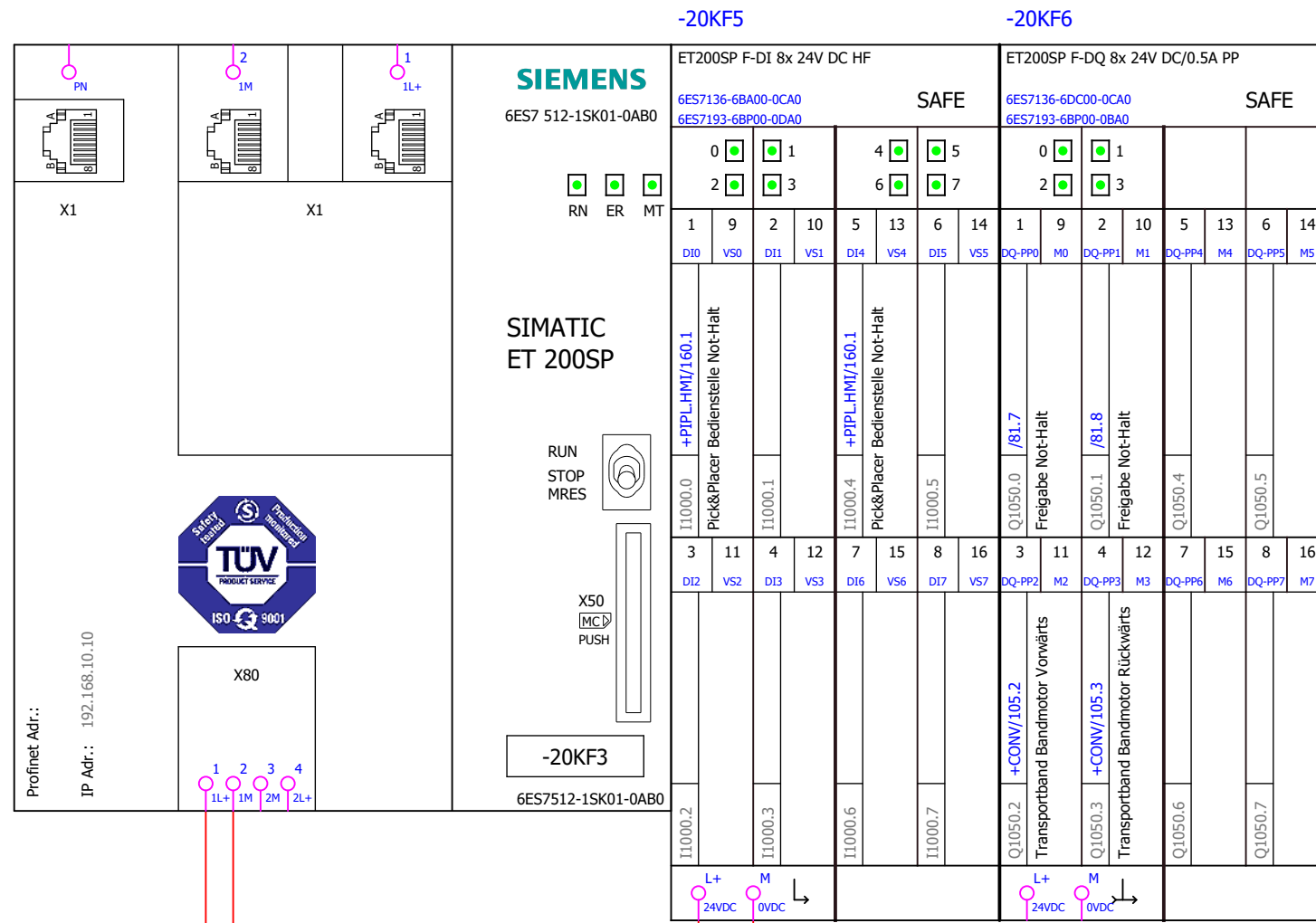

Steuerschrank PN I/O

-21KF1

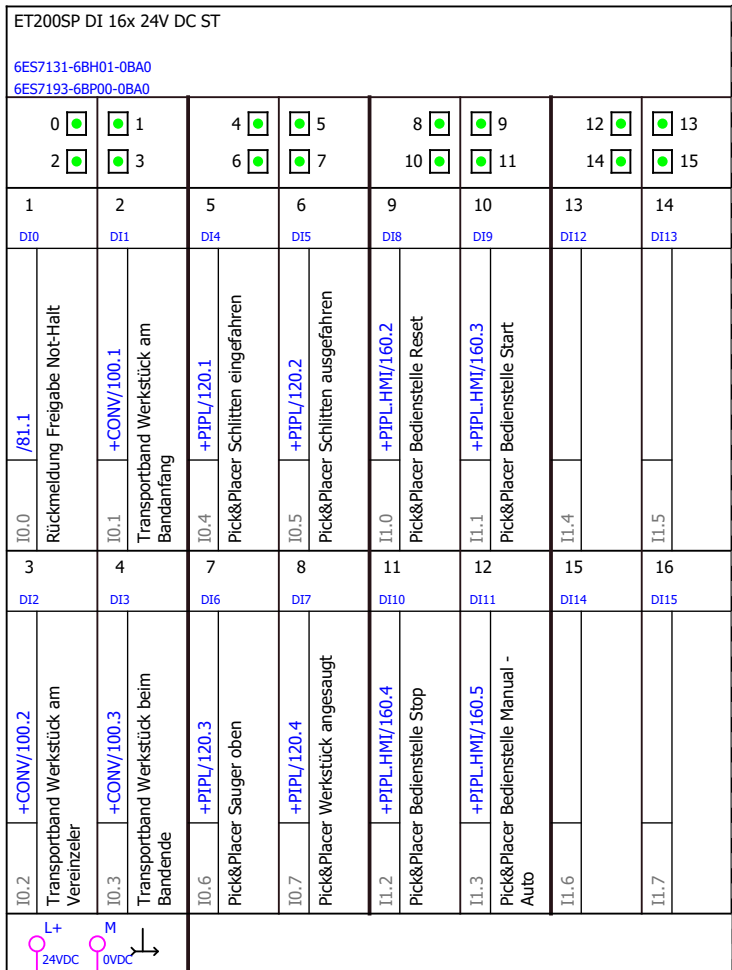

-21KF4

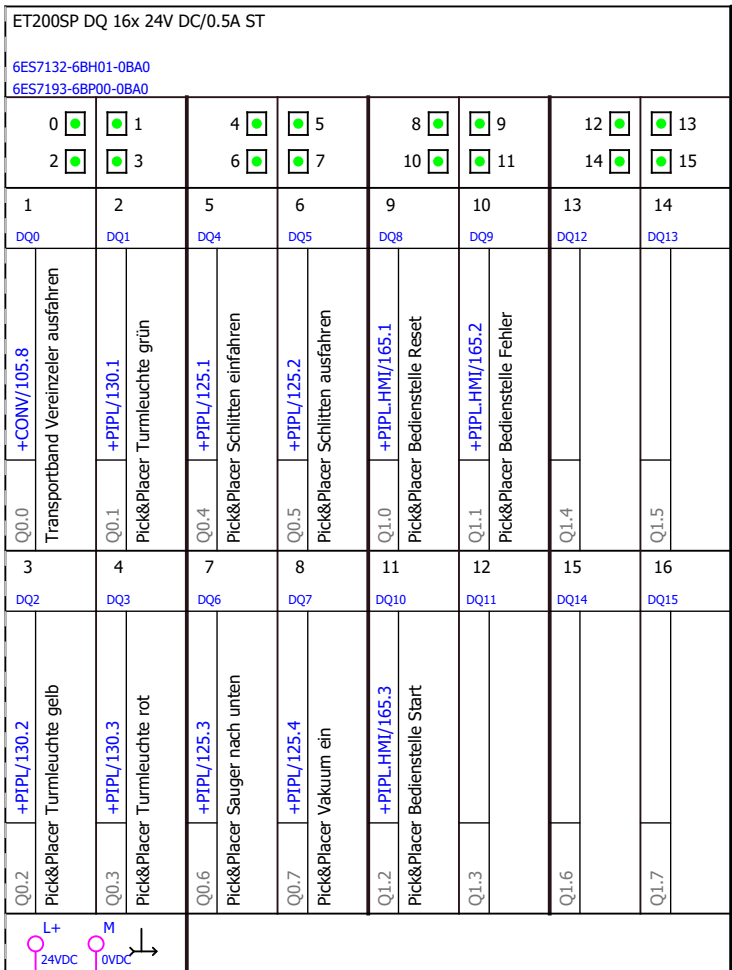

Reserve (nur Schema)

			Revision	Pamasol Willi Mäder AG			SPS Übersicht	Pick_and_Placer	=A1	&EFS			
			Bearb. fabians	Driesbühlstrasse 2					Pick and Placer-Modul		Schaltplan Elektrotechnik		
			Gepr	8808 Pfäffikon Schweiz					+CC		Seite 21		
Änderung	Datum	Name	Datum	11.08.2022	Druckdatum	11.08.2022	Letzte Änderung	25.04.2022 fabians	www.pamasol.com	Pick and Placer	Schulung	Steuerschrank	Blatt 16 von 37

-22KF1

ET200SP AI 2x U/I 2/4-Wire HS											
6ES7134-6HB00-0DA1 6ES7193-6BP00-0DA0											
AI0 <input checked="" type="checkbox"/>		AI1 <input checked="" type="checkbox"/>									
5	7	6	8	9	11	10	12				
I0+	I0-	I1+	I1-	UV0	M0	UV1	M1				
+PIPL/120.8 Pick&Placer Druckluft											
IW272		IW274									
1	3	2	4	13	15	14	16				
U0+	U0-	U1+	U1-	RES	RES	RES	RES				
L+ M 24VDC 0VDC											

-22KF3

ET 200SP, AQ 2xU ST											
6ES7135-6FB00-0BA1 6ES7193-6BP00-0BA0											
0 <input checked="" type="checkbox"/>		1 <input checked="" type="checkbox"/>									
2 <input checked="" type="checkbox"/>		3 <input checked="" type="checkbox"/>									
1	5	2	6		11		12				
Q0+	Q0-	Q1+	Q1-		RES		RES				
+CONV/105.4 Transportband Bandmotor Geschwindigkeit Option											
QW272		QW274									
3	7	4	8		15		16				
RES	RES	RES	RES		RES		RES				
L+ M 24VDC 0VDC											

Reserve
(nur Schema)

			Revision		Pamasol Willi Mäder AG				pamasol Swiss Aerosol Solutions	SPS Übersicht	Pick_and_Placer	=A1	&EFS	
			Bearb.	FABIANS	Driesbühlstrasse 2							Pick and Placer-Modul	Schaltplan Elektrotechnik	
			Gepr		8808	Pfäffikon	Schweiz					+CC	Seite 22	
Änderung	Datum	Name	Datum	11.08.2022	Druckdatum	11.08.2022	Letzte Änderung	18.07.2022	FABIANS	www.pamasol.com	Pick and Placer	Schulung	Steuerschrank	Blatt 17 von 37

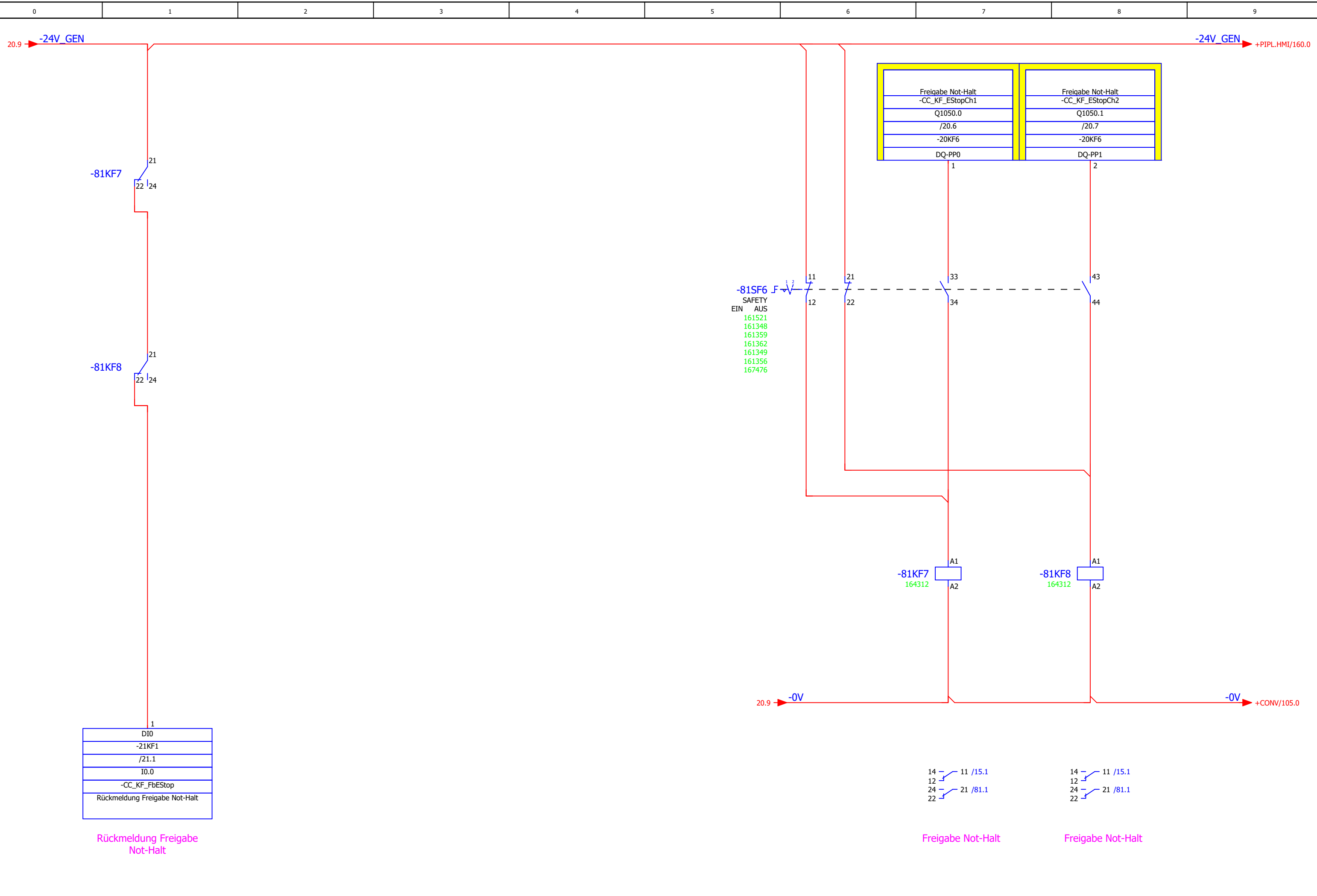

1
DIO
-21KF1
/21.1
IO.0
-CC_KF_FbEStop
Rückmeldung Freigabe Not-Halt

Rückmeldung Freigabe Not-Halt

Freigabe Not-Halt
-CC_KF_EStopCh1
Q1050.0
/20.6
-20KF6
DQ-PP0

Freigabe Not-Halt
-CC_KF_EStopCh2
Q1050.1
/20.7
-20KF6
DQ-PP1

14	11 /15.1
12	21 /81.1
24	21 /81.1
22	

Freigabe Not-Halt

14	11 /15.1
12	21 /81.1
24	21 /81.1
22	

Freigabe Not-Halt

Artikelstückliste

Steuerschrank

+CC

Benennung (BMK)	Bezeichnung	Menge	Artikelnr. Pamasol
-10FC1.1	LS-Schalter, 10kA, 1pol C6	1	161882
-10FC1.1	Hilfsstromschalter 1S+1OE	1	161870
-22KF1	Baseunit Typ A0, BU15-P16+A0+2B	1	122760
-81SF6	Hutschienenmontage-Adapter	1	167476
-5QB1	Lasttrennschalter 3LD, Not-Aus-Schalter, 32A, rot-gelb, Frontbefestigung	1	161495
-8FB1	FI/LS-Schalter, 13A, 30mA, 1p+N	1	161652
-8XB1	Einfachrahmen, FrontCom, Metalldeckel, Schaltschrankschlüssel	1	172478
-8XB1	Einsatz Power, FrontCom, Typ J, Steckdose CH	1	172581
-8XB1	Patchkabel, Datenleitung (konfektioniert), 1m flach schwarz	1	150402
-8XB1	Einsatzplatte, FrontCom, geschirmt, 1x Power, 2x Data	1	172519
-10FC1	LS-Schalter, 10kA, 1pol C6	1	161882
-10TB1	Stromversorgung, 1AC, Ausgang 24V 10A	1	161455
-20KF3	CPU 1512SP F-1 PN, 300KB Prog./1MB Daten	1	167844
-20KF3	SIMATIC S7 Memory Card, 4 MB	1	164075
-20KF3	ET200SP Bus Adapter 2xRJ45	1	133714
-20KF5	ET200SP F-DI 8x 24V DC HF	1	157613
-20KF5	Baseunit Typ A0, BU15-P16+A0+2D	1	122761
-20KF6	ET200SP F-DQ 8x 24V DC/0.5A PP	1	157614
-20KF6	Baseunit Typ A0, BU15-P16+A0+2B	1	122760
-21KF1	ET200SP DI 16x 24V DC ST	1	163591
-21KF1	Baseunit Typ A0, BU15-P16+A0+2B	1	122760
-21KF4	ET200SP DQ 16x 24V DC/0.5A ST	1	163592
-21KF4	Baseunit Typ A0, BU15-P16+A0+2B	1	122760
-22KF1	ET200SP AI 2x U/I 2/4-Wire HS	1	134266
-22KF1	Baseunit Typ A0, BU15-P16+A0+2D	1	122761
-22KF3	ET 200SP, AQ 2xU ST	1	162397
-22KF3	Baseunit Typ A0, BU15-P16+A0+2B	1	122760
-81KF7	Relaismodul, 24V, 2 Wechsler, Zwangsgeführte Kontakte	1	164312
-81KF8	Relaismodul, 24V, 2 Wechsler, Zwangsgeführte Kontakte	1	164312
-81SF6	Drehschalter, O-I, weiss, rastend	1	161521
-81SF6	Halter, 3fach	1	161348
-81SF6	Kontaktmodul, 1S, Frontbefestigung	2	161359
-81SF6	Kontaktmodul, 1OE, Frontbefestigung	2	161362
-81SF6	Schildträger	1	161349
-81SF6	Bezeichnungsschild, silber/schwarz	1	161356

Änderung	Datum	Name	Datum	11.08.2022	Druckdatum	11.08.2022	Letzte Änderung	11.08.2022	FABIANS	www.pamasol.com	Pick and Placer	Schulung	=A1	&EPC
			Revision		Pamasol Willi Mäder AG						Artikelstückliste	Pick_and_Placer	=A1	&EPC
			Bearb.	FABIANS	Driesbüelstrasse 2								Pick and Placer-Modul	Stückliste Elektronik
			Gepr		8808 Pfäffikon Schweiz								+CC	Seite 1000
													Steuerschrank	Blatt 19 von 37

+CC/15.1 → +CC-24V_PP → +CC-24V_PP → +PIPL/120.0
 +CC/15.2 → +CC-0V_PP → +CC-0V_PP → +PIPL/120.0

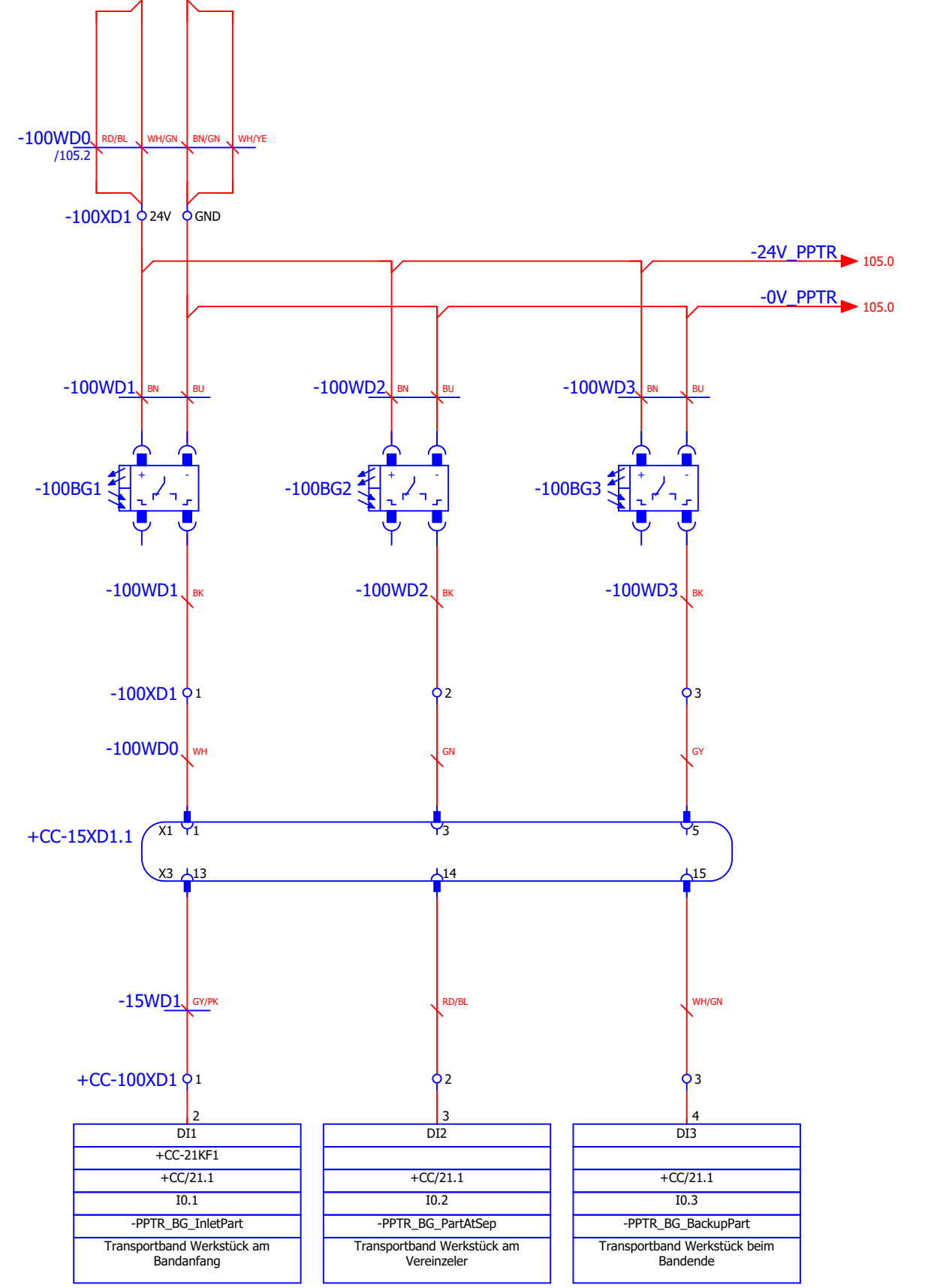

Transportband Werkstück am Bandanfang

Transportband Werkstück am Vereinzeler

Transportband Werkstück beim Bandende

			Revision		Pamasol Willi Mäder AG				 Transportband Eingänge	Pick_and_Placer	=A1	&EFS
			Bearb.	fabians	Driesbüelstrasse 2						Pick and Placer-Modul	Schaltplan Elektrotechnik
			Gepr		8808	Pfäffikon	Schweiz			+CONV	Seite	100
Änderung	Datum	Name	Datum	11.08.2022	Druckdatum	11.08.2022	Letzte Änderung	03.05.2022	fabians	www.pamasol.com	Blatt	20 von 37
									Pick and Placer	Transportband		

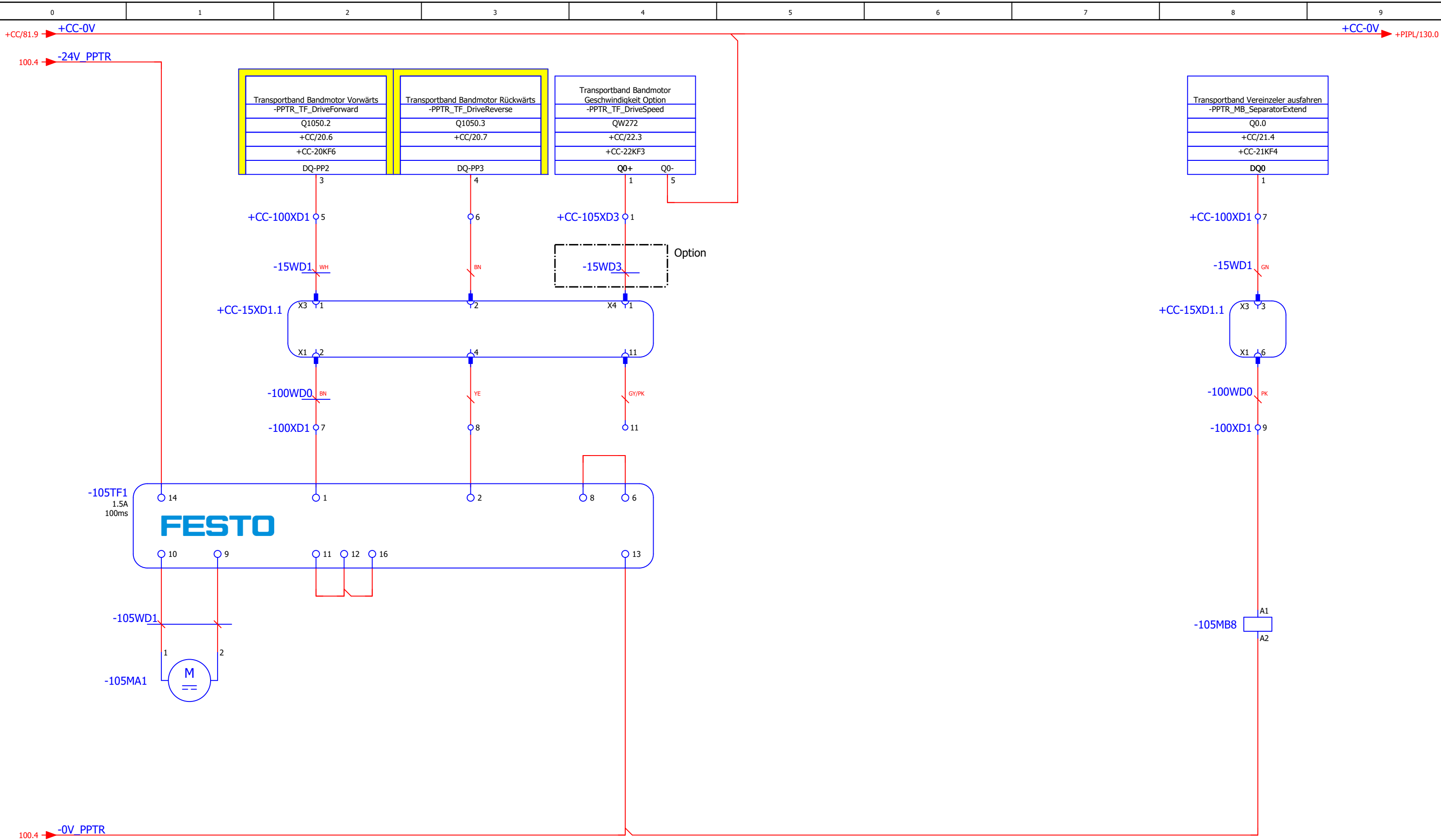

Transportband Bandmotor Vorwärts Transportband Bandmotor Rückwärts Transportband Bandmotor Geschwindigkeit Option Transportband Vereinzeler ausfahren

		Revision		Pamasol Willi Mäder AG		Schweiz		Transportband Ausgänge		Pick_and_Placer		=A1		&EFS	
		Bearb. joelg		Driesbühlstrasse 2		8808 Pfäffikon		pamasol Swiss Aerosol Solutions		Pick and Placer-Modul		Schaltplan Elektrotechnik			
		Gepr		Druckdatum 11.08.2022		Letzte Änderung 12.01.2022		joelg www.pamasol.com		+CONV		Seite 105			
Änderung		Datum		Name		Datum		11.08.2022		Schulung		Transportband		Blatt 21 von 37	

S/N 2.21.102770215.2

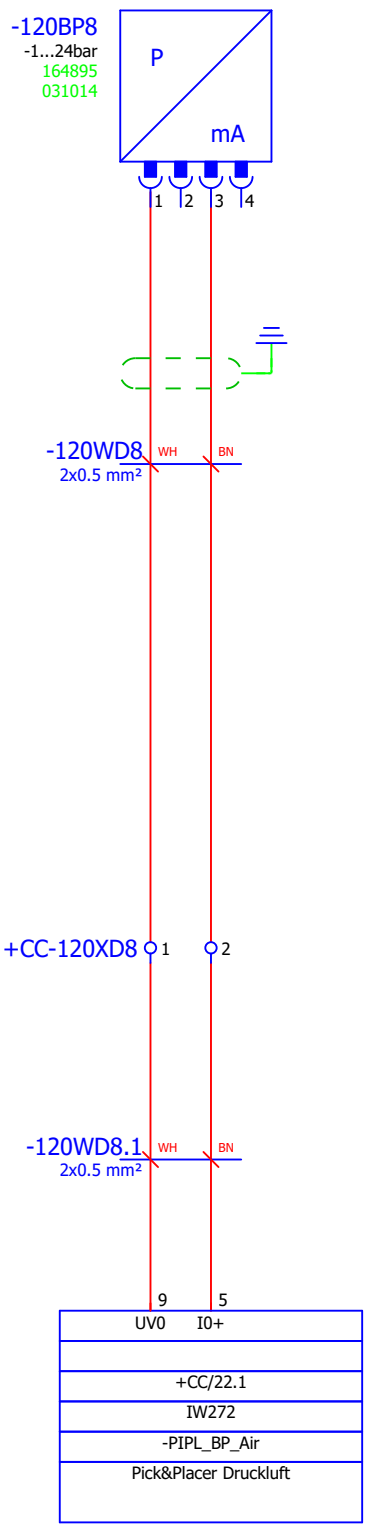
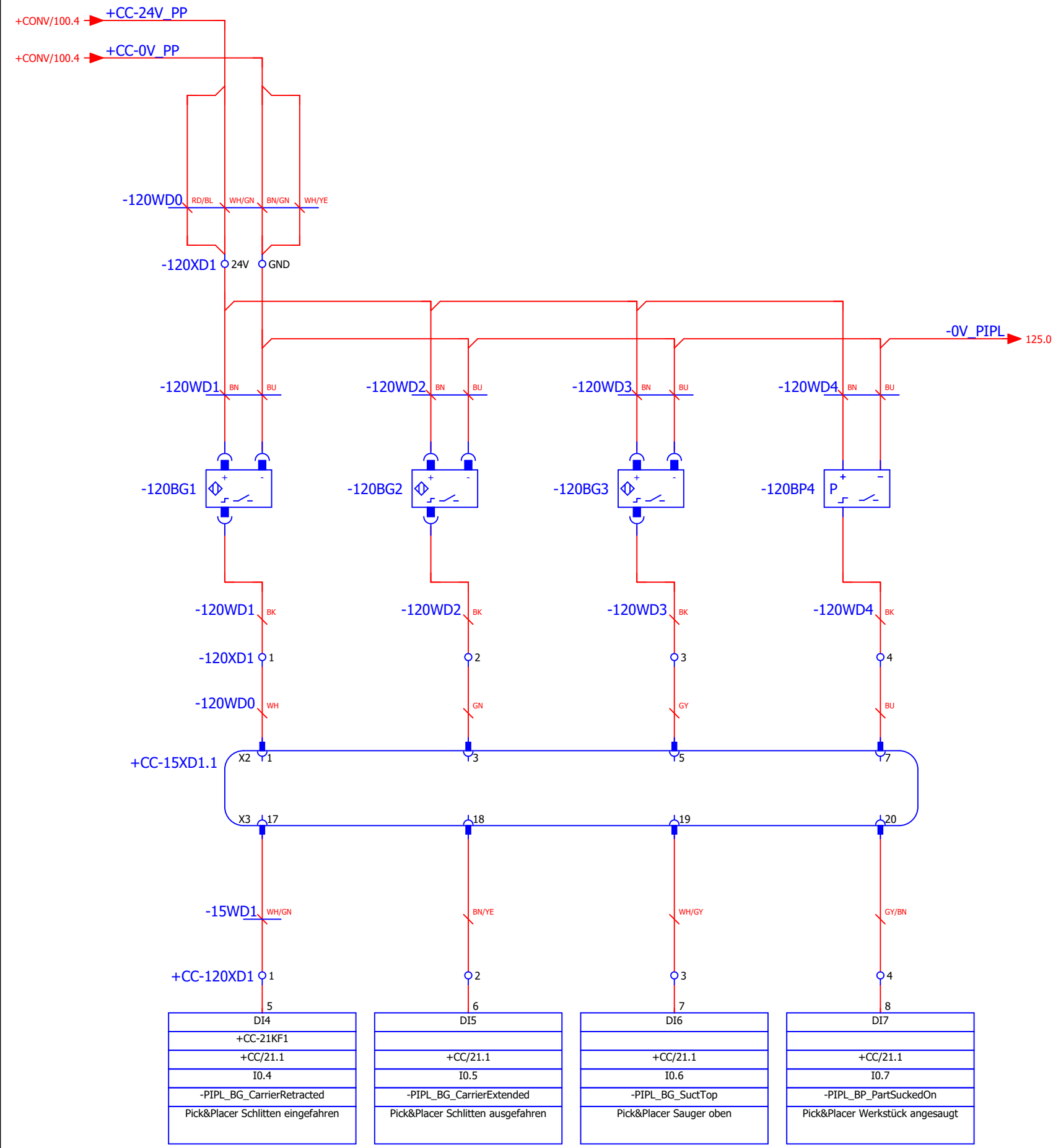

- Pick&Placer Schlitten eingefahren
- Pick&Placer Schlitten ausgefahren
- Pick&Placer Sauger oben
- Pick&Placer Werkstück angesaugt

Pick&Placer Druckluft

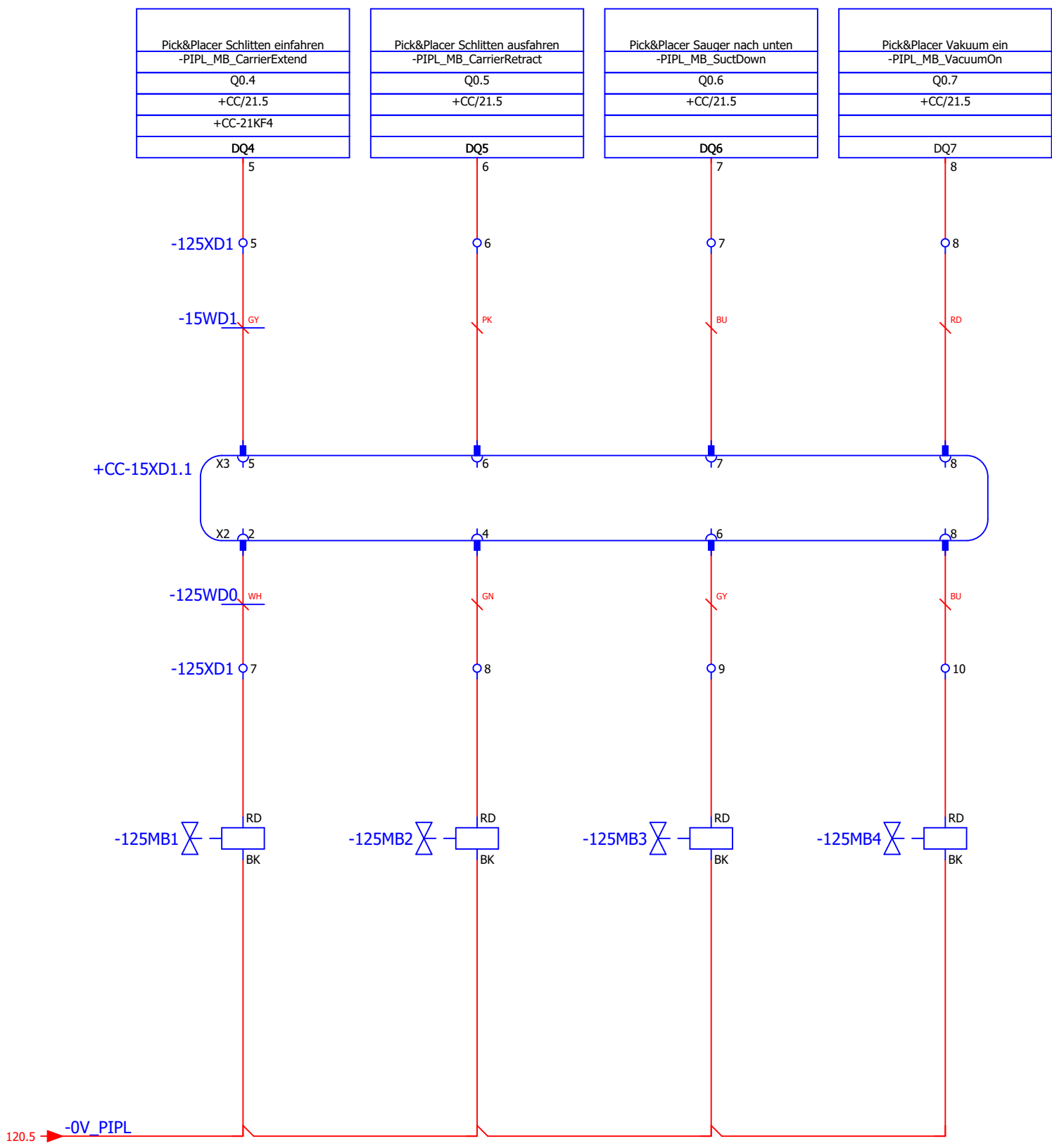

Pick&Placer Schlitten einfahren Pick&Placer Schlitten ausfahren Pick&Placer Sauger nach unten Pick&Placer Vakuum ein

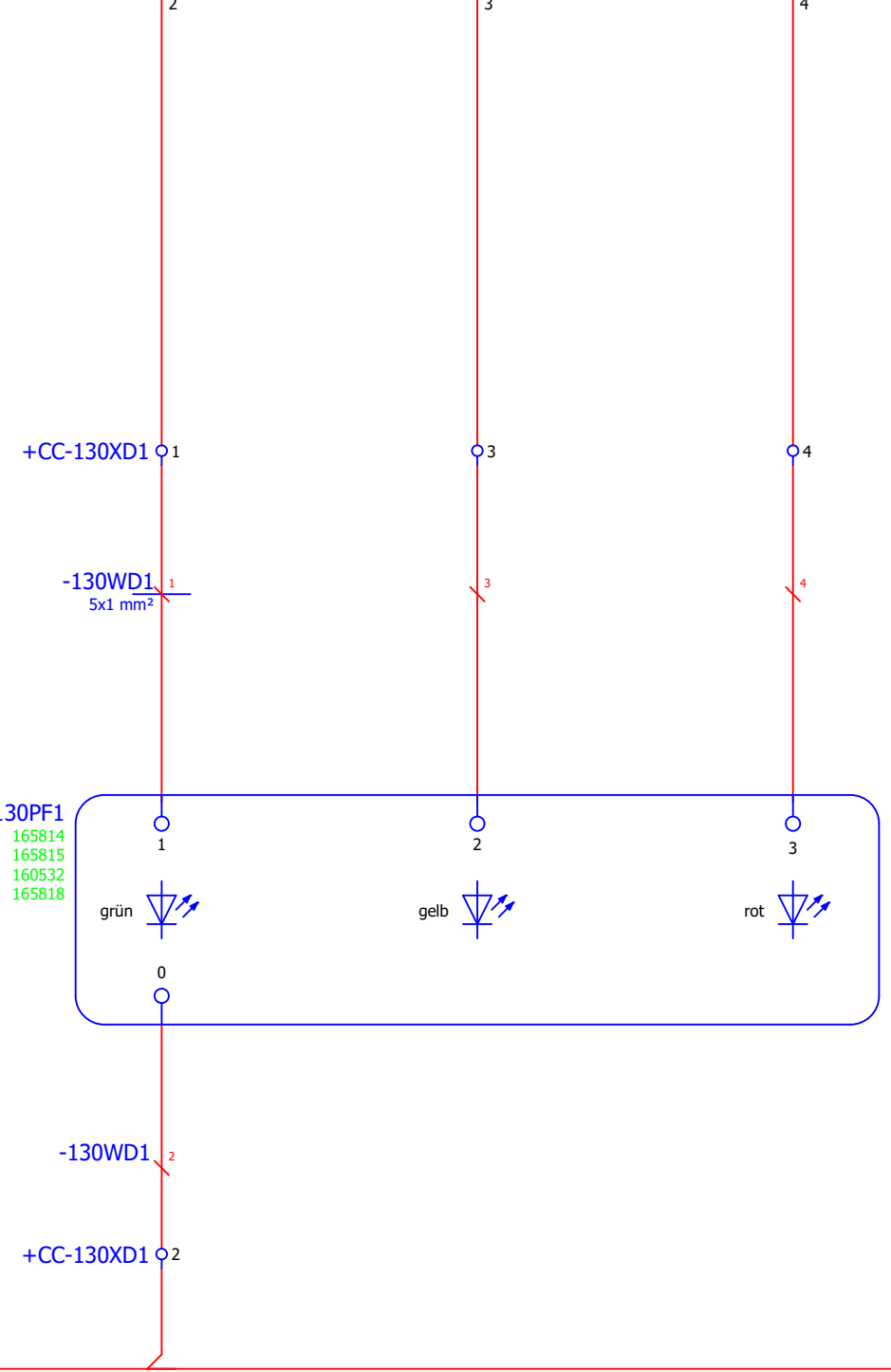
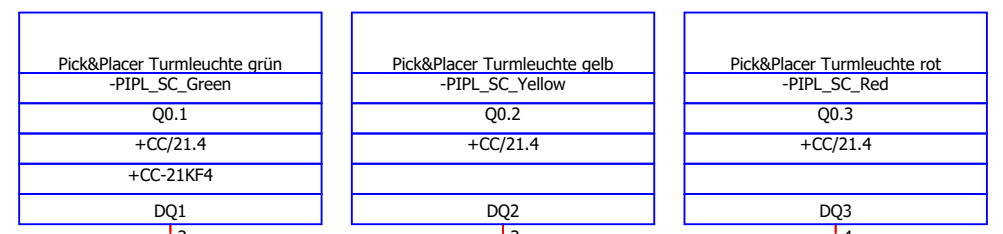

Pick&Placer Turmleuchte grün Pick&Placer Turmleuchte gelb Pick&Placer Turmleuchte rot

+CONV/105.9 → +CC-0V → +CC-0V → +.HMI/165.0

			Revision		Pamasol Willi Mäder AG				 Swiss Aerosol Solutions	Pick&Placer Turmleuchte	Pick_and_Placer	=A1	&EFS
			Bearb.	joelg	Driesbühlstrasse 2							Pick and Placer-Modul	Schaltplan Elektrotechnik
			Gepr		8808	Pfäffikon	Schweiz					+PIPL	Seite 130
Änderung	Datum	Name	Datum	11.08.2022	Druckdatum	11.08.2022	Letzte Änderung	12.01.2022	joelg	www.pamasol.com	Pick and Placer	Pick&Placer	Blatt 24 von 37

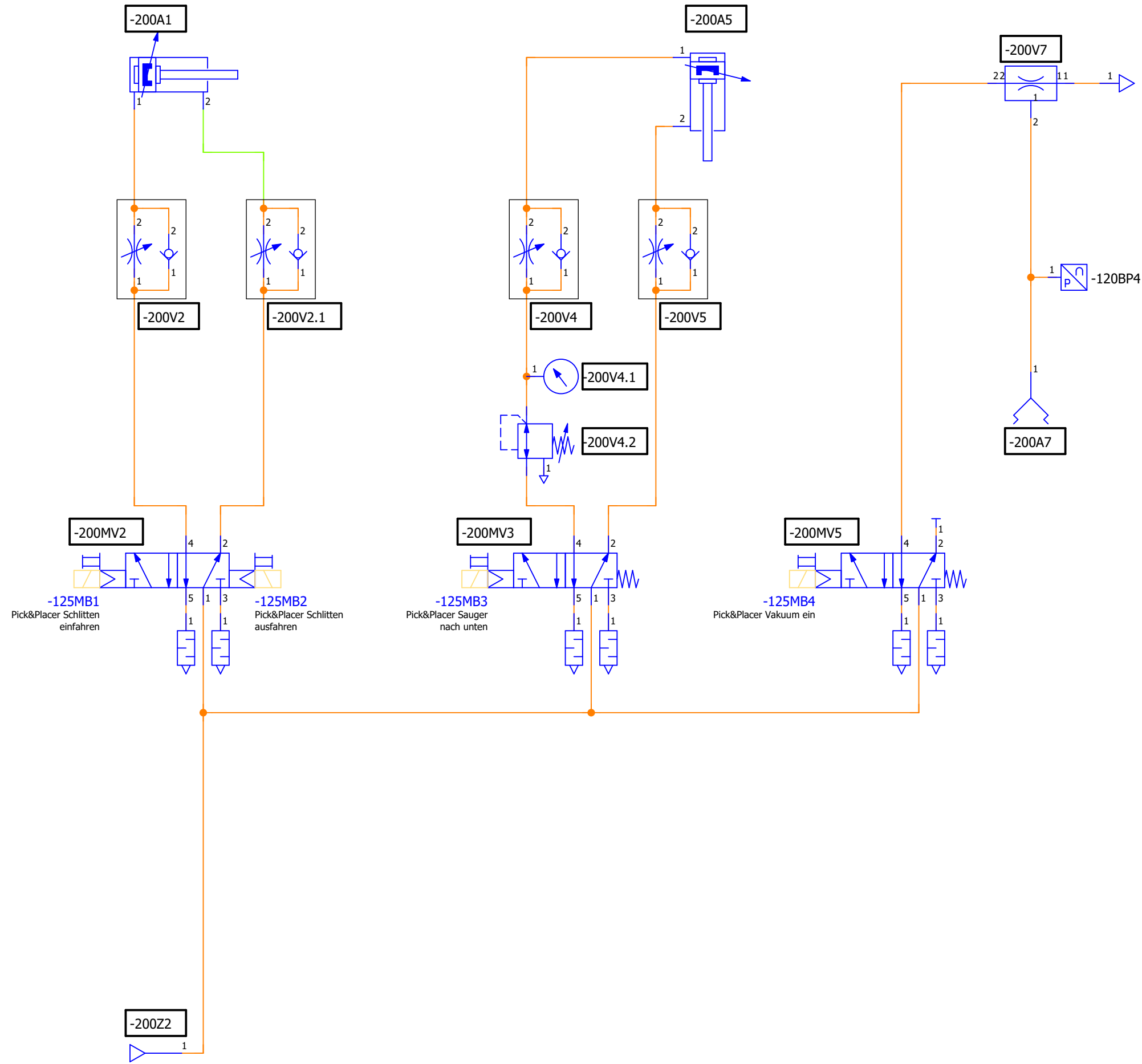

		Revision		Pamasol Willi Mäder AG		pamasol		Pick&Placer Pneumatikschema		Pick_and_Placer		=A1		&MFS11		
		Bearb. fabians		Driesbüelstrasse 2		Swiss Aerosol Solutions				Pick and Placer-Modul		Schaltplan Pneumatik				
		Gepr		8808 Pfäffikon		Schweiz		www.pamasol.com		+PIPL		Seite 200				
Änderung	Datum	Name	Datum	11.08.2022	Druckdatum	11.08.2022	Letzte Änderung	03.05.2022	fabians	Pick and Placer	Schulung		Pick&Placer		Blatt 25 von 37	

Artikelstückliste

Pick&Placer

+PIPL

Benennung (BMK)	Bezeichnung	Menge	Artikelnr. Pamasol
-120BP8	Drucksensor PBMN, Analog 4-20mA, M12, Ex i, -1...24bar, Frontbündig	1	164895
-120BP8	Dose, Rund, M12, 4pol	1	031014
-130PF1	Dauerlichtmodul, grün, LED, 24 V	1	165814
-130PF1	Dauerlichtmodul, rot, LED, 24 V	1	165815
-130PF1	Dauerlichtmodul, gelb, LED, 24 V	1	160532
-130PF1	Basismodul, 100 mm Alurohr mit Fuß	1	165818

		Revision	Pamasol Willi Mäder AG				 <small>Swiss Aerosol Solutions</small>	Artikelstückliste		Pick_and_Placer	=A1	&EPC
		Bearb.	Driesbüelstrasse 2							Pick and Placer-Modul	Stückliste Elektronik	
		Gepr	8808 Pfäffikon Schweiz								+PIPL	Seite 1000
Änderung	Datum	Name	Datum	11.08.2022	Druckdatum	11.08.2022	Letzte Änderung	18.07.2022	FABIANS	www.pamasol.com	Pick and Placer	Blatt 26 von 37
									Schulung	Pick&Placer		

Artikelstückliste

Pick&Placer

+PIPL

Benennung (BMK)	Bezeichnung	Menge	Artikelnr. Pamasol
-U2	Tragschiene	1	025271
-U3	Kabelkanal für Montageplatte, für Schrankbreite 2000 mm, B 40 mm	1	075626
-U4	Tragschiene	1	025271
-U5	Kabelkanal für Montageplatte, für Schrankbreite 2000 mm, B 40 mm	1	075626
-U6	Kabelkanal für Montageplatte, für Schrankbreite 2000 mm, B 40 mm	1	075626
-U8	Tragschiene	1	025271

Änderung		Datum	Name	Datum	Druckdatum	11.08.2022	Letzte Änderung	20.08.2021	fabians	www.pamasol.com	Pick and Placer	Schulung	+PIPL	Pick&Placer	Seite	1100	Blatt	27	von	37
Revision					Pamasol Willi Mäder AG						Artikelstückliste		=A1							
Bearb.				fabians	Driesbühlstrasse 2						Pick_and_Placer		Pick and Placer-Modul		Stückliste Mechanik					
Gepr					8808 Pfäffikon				Schweiz		pamasol		+PIPL		Seite		1100			
											www.pamasol.com		Pick&Placer		Blatt		27		von 37	

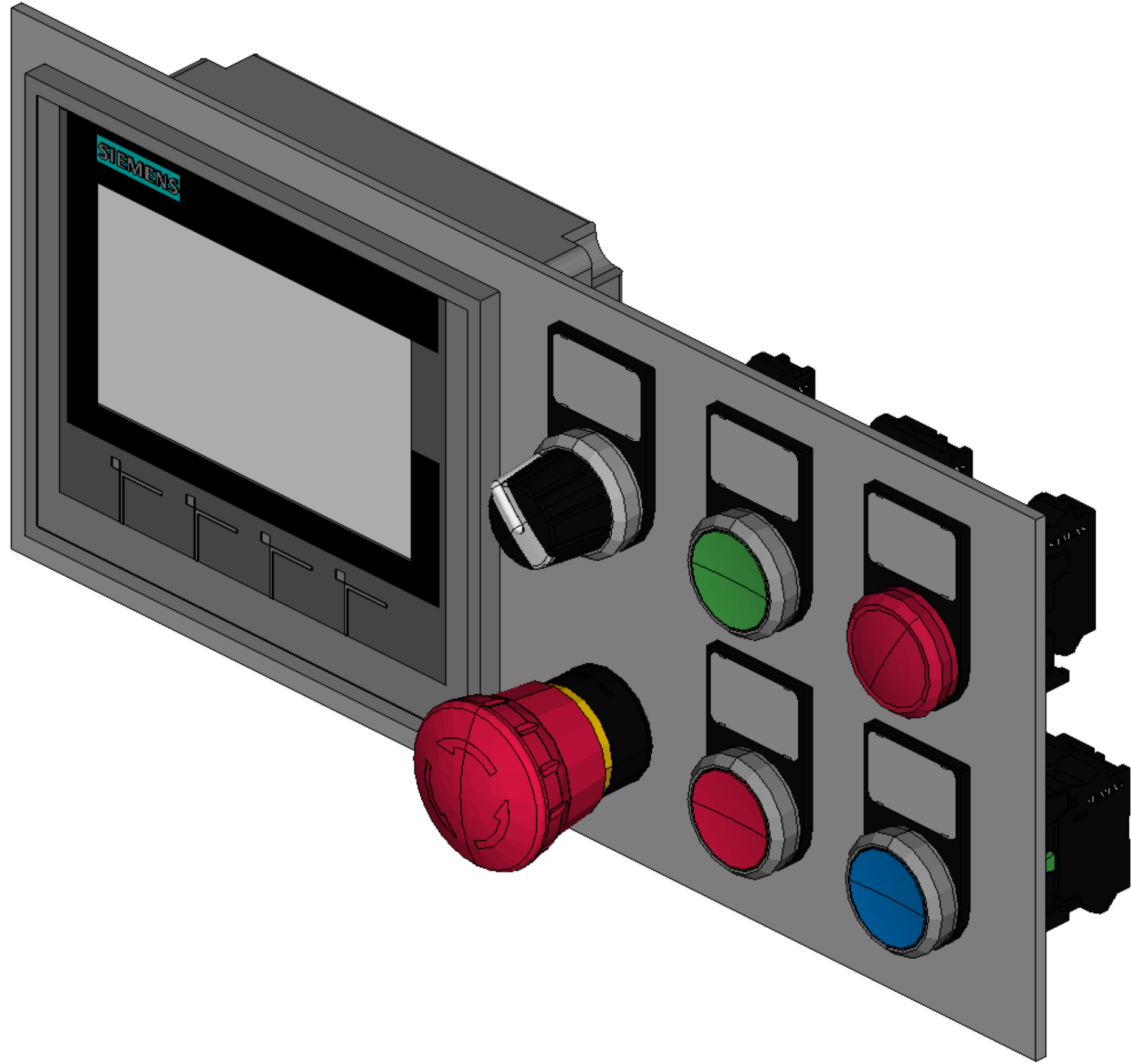

			Revision		Pamasol Willi Mäder AG					Schaltschrankdisposition - 3D Ansicht	Pick_and_Placer	=A1	&MTL		
			Bearb.	FABIANS	Driesbühlstrasse 2							Pick and Placer-Modul	Schaltschrankdisposition		
			Gepr		8808	Pfäffikon	Schweiz					+PIPL.HMI	Seite	1	
Änderung	Datum	Name	Datum	11.08.2022	Druckdatum	11.08.2022	Letzte Änderung	11.08.2022	FABIANS	www.pamasol.com	Schulung	Pick&Placer Bedienstelle	Blatt	28 von	37

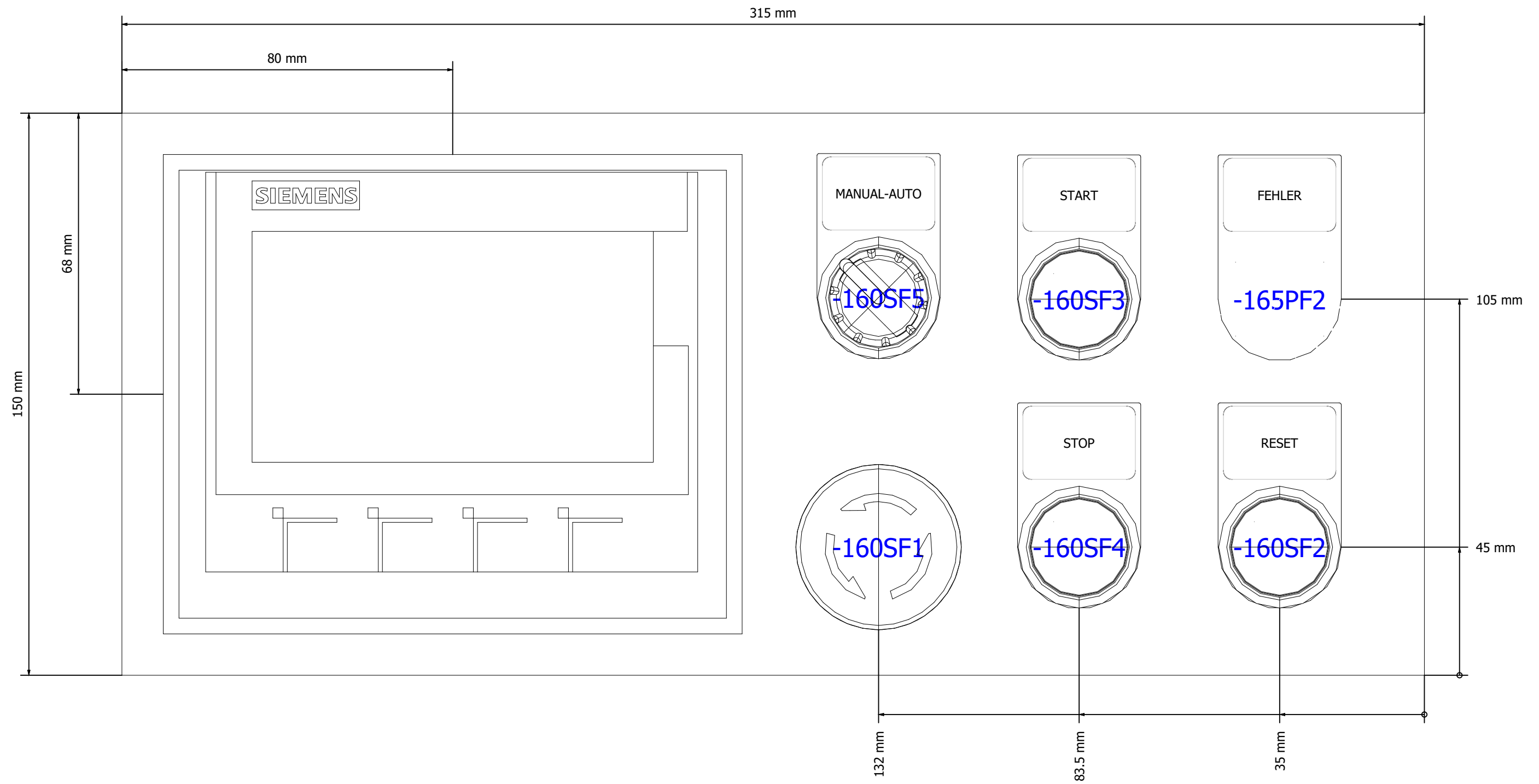

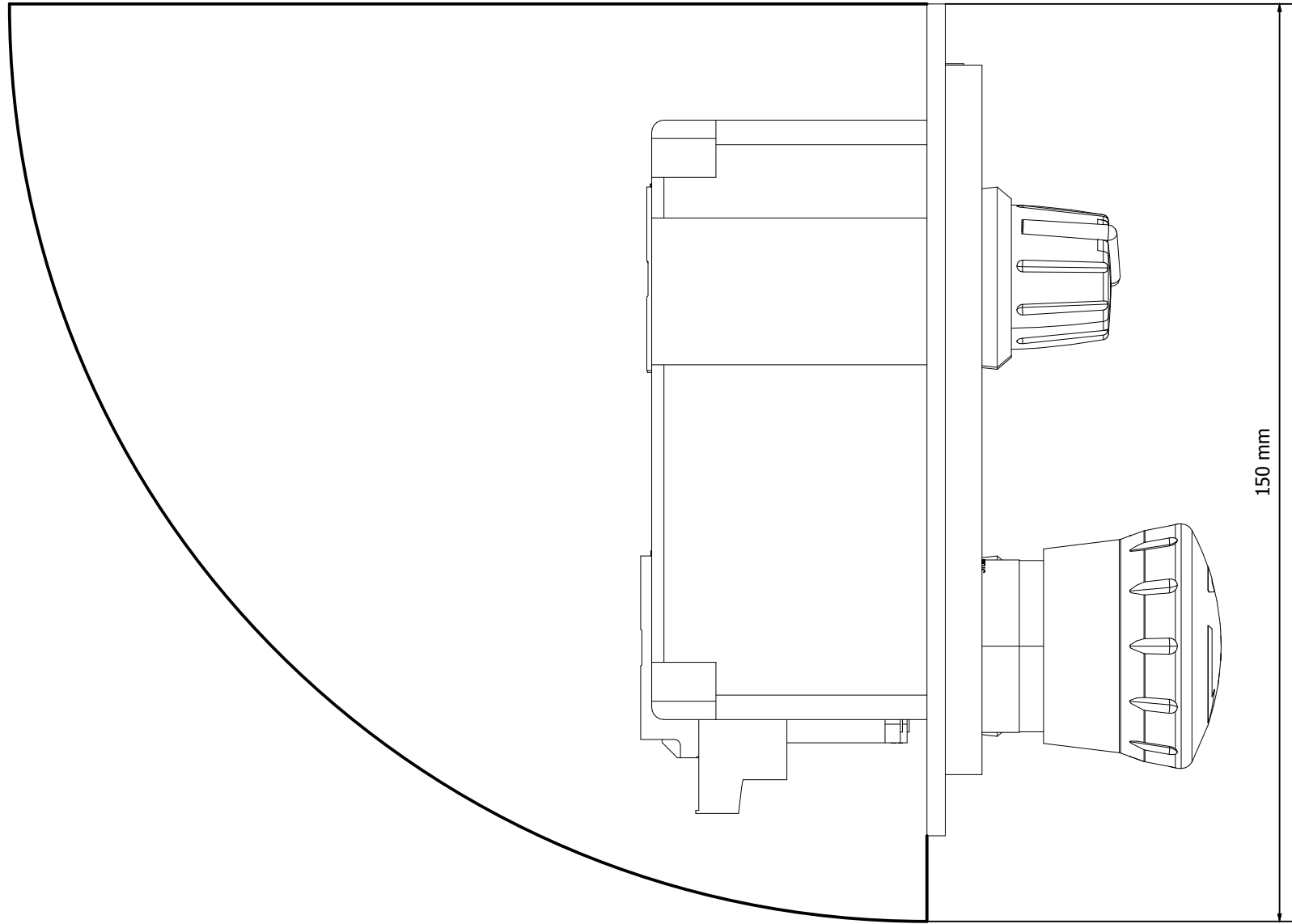

150 mm

			Revision		Pamasol Willi Mäder AG					Schaltschrankdisposition - 3D Ansicht	Pick_and_Placer	=A1	&MTL			
			Bearb.	FABIANS	Driesbühlstrasse 2						Pick and Placer-Modul	Schaltschrankdisposition				
			Gepr		8808	Pfäffikon	Schweiz	Swiss Aerosol Solutions			+PIPL.HMI	Seite	3			
Änderung	Datum	Name	Datum	11.08.2022	Druckdatum	11.08.2022	Letzte Änderung	11.08.2022	FABIANS	www.pamasol.com	Pick and Placer	Schulung	Pick&Placer Bedienstelle	Blatt	30 von	37

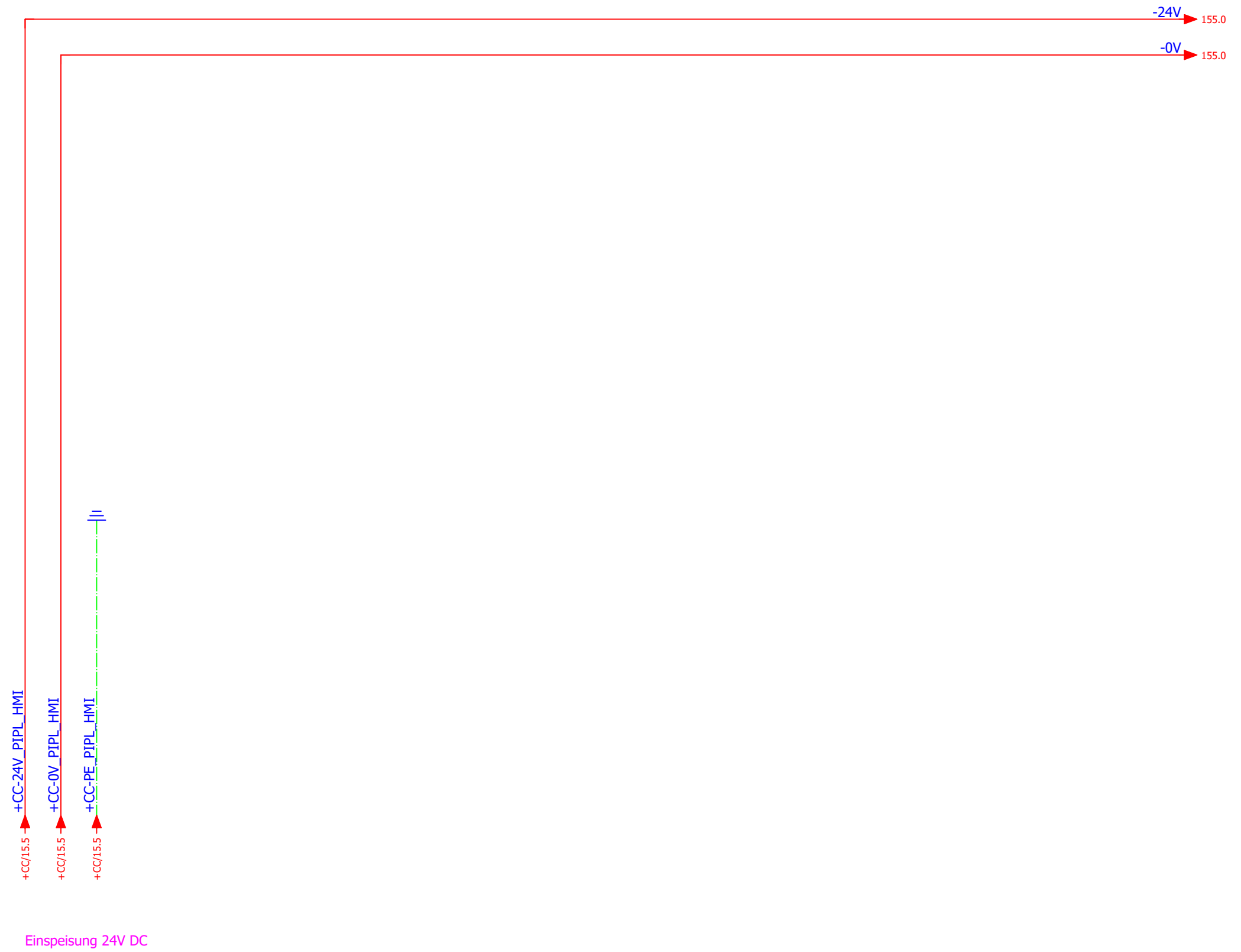

			Revision		Pamasol Willi Mäder AG				 Pick&Placer Bedienstelle Einspeisung	Pick_and_Placer	=A1	&EFS
			Bearb.	fabians	Driesbühlstrasse 2					Pick and Placer-Modul	Schaltplan Elektrotechnik	
			Gepr		8808	Pfäffikon	Schweiz	www.pamasol.com		Schulung	+PIPL.HMI	Seite 150
Änderung	Datum	Name	Datum	11.08.2022	Druckdatum	11.08.2022	Letzte Änderung	19.08.2021	fabians	Pick and Placer	Pick&Placer Bedienstelle	Blatt 31 von 37

-155PH1

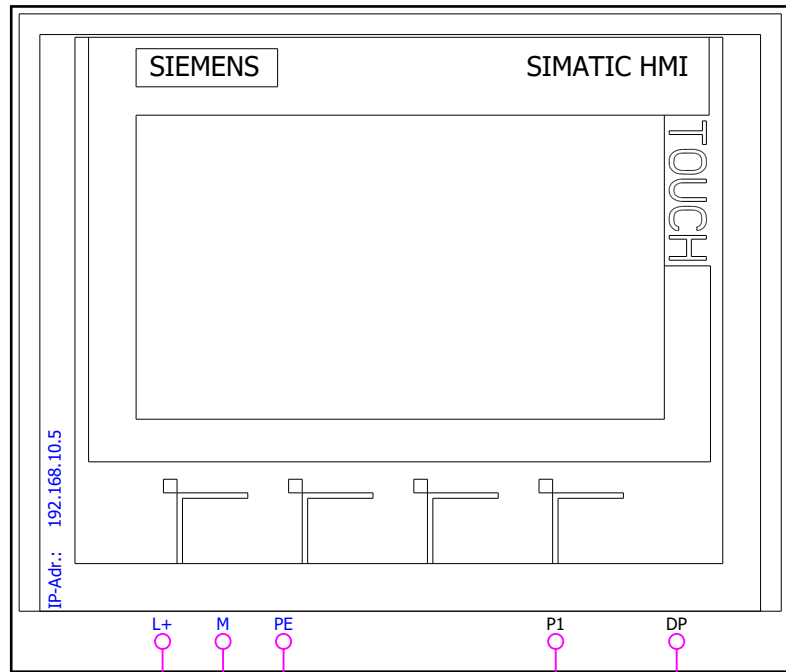

150.9 -24V

150.9 -0V

Pick&Placer Bedienstelle Panel

			Revision		Pamasol Willi Mäder AG				 Pick&Placer Bedienstelle Panel	Pick_and_Placer	=A1	&EFS		
			Bearb.	fabians	Driesbuelstrasse 2						Pick and Placer-Modul	Schaltplan Elektrotechnik		
			Gepr		8808	Pfäffikon	Schweiz				+PIPL.HMI	Seite 155		
Änderung	Datum	Name	Datum	11.08.2022	Druckdatum	11.08.2022	Letzte Änderung	25.04.2022	fabians	www.pamasol.com	Pick and Placer	Schulung	Pick&Placer Bedienstelle	Blatt 32 von 37

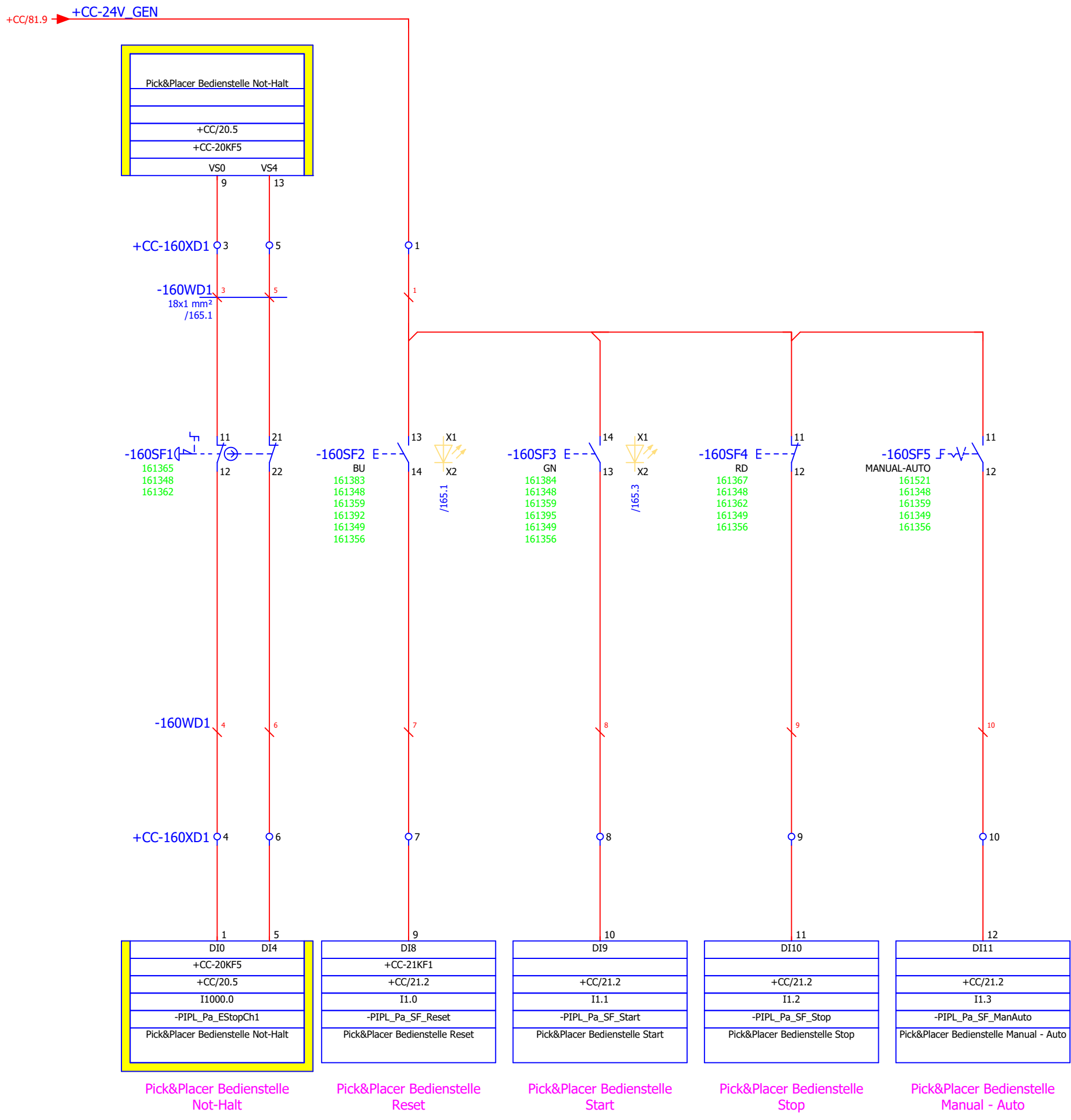

Pick&Placer Bedienstelle Not-Halt Pick&Placer Bedienstelle Reset Pick&Placer Bedienstelle Start Pick&Placer Bedienstelle Stop Pick&Placer Bedienstelle Manual - Auto

				Revision	Pamasol Willi Mäder AG				 Pick&Placer Bedienstelle Eingänge	Pick_and_Placer	=A1	&EFS		
				Bearb.	Driesbühlstrasse 2						Pick and Placer-Modul	Schaltplan Elektrotechnik		
				Gepr	8808 Pfäffikon Schweiz						+PIPL.HMI	Seite 160		
Änderung	Datum	Name	Datum	11.08.2022	Druckdatum	11.08.2022	Letzte Änderung	03.05.2022	fabians	www.pamasol.com	Pick and Placer	Schulung	Pick&Placer Bedienstelle	Blatt 33 von 37

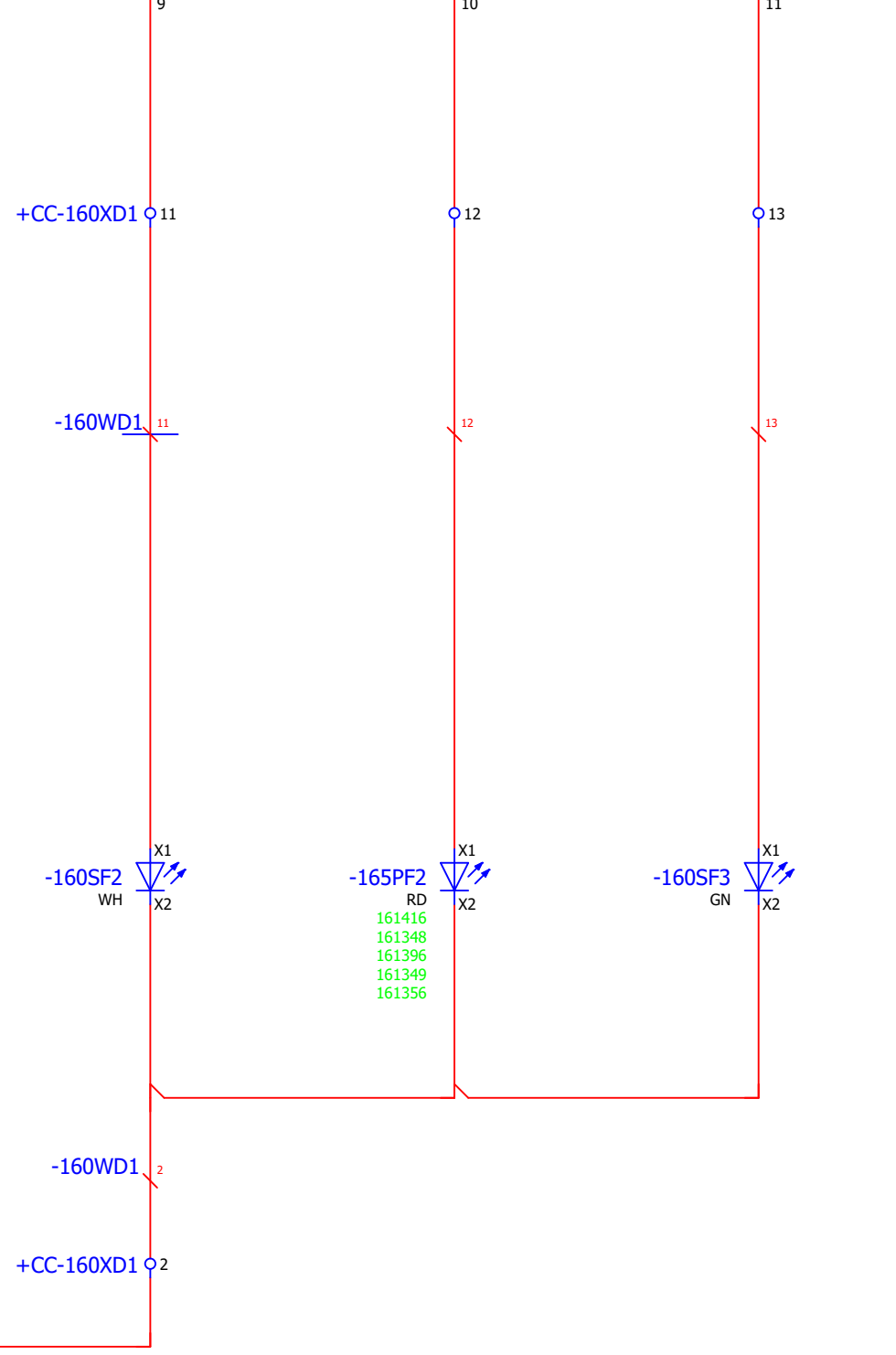
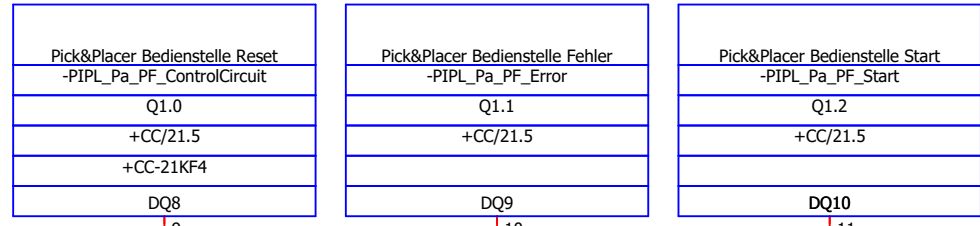

Pick&Placer Bedienstelle Reset Pick&Placer Bedienstelle Fehler Pick&Placer Bedienstelle Start

		Revision		Pamasol Willi Mäder AG		Pick&Placer Bedienstelle Ausgänge		Pick_and_Placer		=A1		&EFS	
		Bearb. joelg		Driesbühlstrasse 2				Schulung		Pick and Placer-Modul		Schaltplan Elektrotechnik	
		Gepr		8808 Pfäffikon		Schweiz				+PIPL.HMI		Seite 165	
Änderung		Datum		Name		Datum		11.08.2022		Druckdatum		11.08.2022	
						Letzte Änderung		28.04.2022		joelg		www.pamasol.com	
										Pick and Placer		Blatt 34 von 37	

Artikelstückliste

Pick&Placer

+PIPL.HMI

Benennung (BMK)	Bezeichnung	Menge	Artikelnr. Pamasol
-155PH1	Simatic HMI KTP400 Comfort, 4-Zoll TFT Display, 4 Tasten	1	135605
-155PH1	SD-Karte, 32mm x 24mm	1	
-160SF1	Not-Halt-Pilzdrucktaster, 40mm, rot	1	161365
-160SF1	Halter, 3fach	1	161348
-160SF1	Kontaktmodul, 1OE, Frontbefestigung	2	161362
-160SF2	Leuchtdrucktaster, blau	1	161383
-160SF2	Halter, 3fach	1	161348
-160SF2	Kontaktmodul, 1S, Frontbefestigung	1	161359
-160SF2	LED-Modul, blau	1	161392
-160SF2	Schildträger	1	161349
-160SF2	Bezeichnungsschild, silber/schwarz	1	161356
-160SF3	Leuchtdrucktaster, grün	1	161384
-160SF3	Halter, 3fach	1	161348
-160SF3	Kontaktmodul, 1S, Frontbefestigung	1	161359
-160SF3	LED-Modul, grün	1	161395
-160SF3	Schildträger	1	161349
-160SF3	Bezeichnungsschild, silber/schwarz	1	161356
-160SF4	Drucktaster, rot	1	161367
-160SF4	Halter, 3fach	1	161348
-160SF4	Kontaktmodul, 1OE, Frontbefestigung	1	161362
-160SF4	Schildträger	1	161349
-160SF4	Bezeichnungsschild, silber/schwarz	1	161356
-160SF5	Drehschalter, O-I, weiss, rastend	1	161521
-160SF5	Halter, 3fach	1	161348
-160SF5	Kontaktmodul, 1S, Frontbefestigung	1	161359
-160SF5	Schildträger	1	161349
-160SF5	Bezeichnungsschild, silber/schwarz	1	161356
-165PF2	Leuchtmelder, rot	1	161416
-165PF2	Halter, 3fach	1	161348
-165PF2	LED-Modul, rot	1	161396
-165PF2	Schildträger	1	161349
-165PF2	Bezeichnungsschild, silber/schwarz	1	161356

		Revision		Pamasol Willi Mäder AG				Artikelstückliste		Pick_and_Placer		=A1		&EPC	
		Bearb. fabians		Driesbüelstrasse 2				Pick and Placer-Modul		Stückliste Elektronik					
		Gepr		8808 Pfäffikon Schweiz		Swiss Aerosol Solutions				Schulung		+PIPL.HMI		Seite 1000	
Änderung	Datum	Name	Datum	11.08.2022	Druckdatum	11.08.2022	Letzte Änderung	20.08.2021	fabians	www.pamasol.com	Pick and Placer	Pick&Placer Bedienstelle	Blatt	35 von	37

Artikelsummenstückliste

Artikelnr.	Bezeichnung	Menge
	SD-Karte, 32mm x 24mm	1
025271	Tragschiene	3
031014	Dose, Rund, M12, 4pol	1
075626	Kabelkanal für Montageplatte, für Schrankbreite 2000 mm, B 40 mm	3
122760	Baseunit Typ A0, BU15-P16+A0+2B	5
122761	Baseunit Typ A0, BU15-P16+A0+2D	2
133714	ET200SP Bus Adapter 2xRJ45	1
134266	ET200SP AI 2x U/I 2/4-Wire HS	1
135605	Simatic HMI KTP400 Comfort, 4-Zoll TFT Display, 4 Tasten	1
150402	Patchkabel, Datenleitung (konfektioniert), 1m flach schwarz	1
157613	ET200SP F-DI 8x 24V DC HF	1
157614	ET200SP F-DQ 8x 24V DC/0.5A PP	1
160532	Dauerlichtmodul, gelb, LED, 24 V	1
161348	Halter, 3fach	7
161349	Schildträger	6
161356	Bezeichnungsschild, silber/schwarz	6
161359	Kontaktmodul, 1S, Frontbefestigung	5
161362	Kontaktmodul, 10E, Frontbefestigung	5
161365	Not-Halt-Pilzdrucktaster, 40mm, rot	1
161367	Drucktaster, rot	1
161383	Leuchtdrucktaster, blau	1
161384	Leuchtdrucktaster, grün	1
161392	LED-Modul, blau	1
161395	LED-Modul, grün	1
161396	LED-Modul, rot	1
161416	Leuchtmelder, rot	1
161455	Stromversorgung, 1AC, Ausgang 24V 10A	1
161495	Lasttrennschalter 3LD, Not-Aus-Schalter, 32A, rot-gelb, Frontbefestigung	1
161521	Drehschalter, O-I, weiss, rastend	2
161652	FJ/LS-Schalter, 13A, 30mA, 1p+N	1
161870	Hilfsstromschalter 1S+10E	1
161882	LS-Schalter, 10kA, 1pol C6	2
162397	ET 200SP, AQ 2xU ST	1
163591	ET200SP DI 16x 24V DC ST	1
163592	ET200SP DQ 16x 24V DC/0.5A ST	1
164075	SIMATIC S7 Memory Card, 4 MB	1
164312	Relaismodul, 24V, 2 Wechsler, Zwangsgeführte Kontakte	2
164895	Drucksensor PBMN, Analog 4-20mA, M12, Ex i, -1...24bar, Frontbündig	1
165814	Dauerlichtmodul, grün, LED, 24 V	1

165815	Dauerlichtmodul, rot, LED, 24 V	1
165818	Basismodul, 100 mm Alurohr mit Fuß	1
167476	Hutschiennenmontage-Adapter	1
167844	CPU 1512SP F-1 PN, 300KB Prog./1MB Daten	1
172478	Einfachrahmen, FrontCom, Metalldeckel, Schaltschrankschlüssel	1
172519	Einsatzplatte, FrontCom, geschirmt, 1x Power, 2x Data	1
172581	Einsatz Power, FrontCom, Typ J, Steckdose CH	1

			Revision		Pamasol Willi Mäder AG				 Swiss Aerosol Solutions	Artikelsummenstückliste		Pick_and_Placer	=A1	&EPA
			Bearb.	FABIANS	Driesbühlstrasse 2						Pick and Placer-Modul	Artikelsummenstückliste		
			Gepr		8808	Pfäffikon	Schweiz				+Reports	Seite 1000		
Änderung	Datum	Name	Datum	11.08.2022	Druckdatum	11.08.2022	Letzte Änderung	11.08.2022	FABIANS	www.pamasol.com	Pick and Placer	Schulung		Blatt 36 von 37

Kabelübersicht

Kabelbezeichnung	von	bis	Kabel Ø (mm)	Adern	Länge (m)	Funktionstext
-15WD5	+CC-15XD5	+PIPL.HMI-155PH1	5.90	3x1 mm ²		Einspeisung Bedienstelle
-120WD8	+CC-120XD8	+PIPL-120BP8	5.20	2x0.5 mm ²		Pick&Placer Druckluft
-120WD8.1	+CC-120XD8	+CC-22KF1	5.20	2x0.5 mm ²		=
-130WD1	+CC-130XD1	+PIPL-130PF1	7.30	5x1 mm ²		Turmleuchte
-160WD1	+CC-160XD1	+PIPL.HMI-160SF1	12.80	18x1 mm ²		Pick&Placer Bedienstelle Not-Halt
-1WF1	+CC-20KF3	+CC-8XB1	5.7	4x2x27 AWG	1	
-1WF2	+CC-20KF3	+PIPL.HMI-155PH1	5.7	4x2x27 AWG	1	

		Revision		Pamasol Willi Mäder AG		 Kabelübersicht : =A1-15WD5 - =A1-1WF2		Pick_and_Placer		=A1		&EMB	
		Bearb. FABIANS		Driesbüelstrasse 2				Pick and Placer-Modul		Kabelübersicht			
		Gepr		8808 Pfäffikon Schweiz		www.pamasol.com		Schulung		+Reports		Seite 1000	
Änderung	Datum	Name	Datum	11.08.2022	Druckdatum	11.08.2022	Letzte Änderung	18.07.2022	FABIANS	Pick and Placer	Blatt		37 von 37

